

# Series 2400 SourceMeter®

## Quick Start Guide

2400S-903-01 Rev. E / September 2011



致力于电子测试、维护领域!



# Safety Precautions

---

The following safety precautions should be observed before using this product and any associated instrumentation. Although some instruments and accessories would normally be used with non-hazardous voltages, there are situations where hazardous conditions may be present.

This product is intended for use by qualified personnel who recognize shock hazards and are familiar with the safety precautions required to avoid possible injury. Read and follow all installation, operation, and maintenance information carefully before using the product. Refer to the user documentation for complete product specifications.

If the product is used in a manner not specified, the protection provided by the product warranty may be impaired.

The types of product users are:

**Responsible body** is the individual or group responsible for the use and maintenance of equipment, for ensuring that the equipment is operated within its specifications and operating limits, and for ensuring that operators are adequately trained.

**Operators** use the product for its intended function. They must be trained in electrical safety procedures and proper use of the instrument. They must be protected from electric shock and contact with hazardous live circuits.

**Maintenance personnel** perform routine procedures on the product to keep it operating properly, for example, setting the line voltage or replacing consumable materials. Maintenance procedures are described in the user documentation. The procedures explicitly state if the operator may perform them. Otherwise, they should be performed only by service personnel.

**Service personnel** are trained to work on live circuits, perform safe installations, and repair products. Only properly trained service personnel may perform installation and service procedures.

Keithley Instruments products are designed for use with electrical signals that are rated Measurement Category I and Measurement Category II, as described in the International Electrotechnical Commission (IEC) Standard IEC 60664. Most measurement, control, and data I/O signals are Measurement Category I and must not be directly connected to mains voltage or to voltage sources with high transient over-voltages. Measurement Category II connections require protection for high transient over-voltages often associated with local AC mains connections. Assume all measurement, control, and data I/O connections are for connection to Category I sources unless otherwise marked or described in the user documentation.

Exercise extreme caution when a shock hazard is present. Lethal voltage may be present on cable connector jacks or test fixtures. The American National Standards Institute (ANSI) states that a shock hazard exists when voltage levels greater than 30V RMS, 42.4V peak, or 60VDC are present. A good safety practice is to expect that hazardous voltage is present in any unknown circuit before measuring.

Operators of this product must be protected from electric shock at all times. The responsible body must ensure that operators are prevented access and/or insulated from every connection point. In some cases, connections must be exposed to potential human contact. Product operators in these circumstances must be trained to protect themselves from the risk of electric shock. If the circuit is capable of operating at or above 1000V, no conductive part of the circuit may be exposed.

Do not connect switching cards directly to unlimited power circuits. They are intended to be used with impedance-limited sources. NEVER connect switching cards directly to AC mains. When connecting sources to switching cards, install protective devices to limit fault current and voltage to the card.

Before operating an instrument, ensure that the line cord is connected to a properly-grounded power receptacle. Inspect the connecting cables, test leads, and jumpers for possible wear, cracks, or breaks before each use.

When installing equipment where access to the main power cord is restricted, such as rack mounting, a separate main input power disconnect device must be provided in close proximity to the equipment and within easy reach of the operator.

For maximum safety, do not touch the product, test cables, or any other instruments while power is applied to the circuit under test. ALWAYS remove power from the entire test system and discharge any capacitors before: connecting or disconnecting cables or jumpers, installing or removing switching cards, or making internal changes, such as installing or removing jumpers.

Do not touch any object that could provide a current path to the common side of the circuit under test or power line (earth) ground. Always make measurements with dry hands while standing on a dry, insulated surface capable of withstanding the voltage being measured.

The instrument and accessories must be used in accordance with its specifications and operating instructions, or the safety of the equipment may be impaired.

Do not exceed the maximum signal levels of the instruments and accessories, as defined in the specifications and operating information, and as shown on the instrument or test fixture panels, or switching card.

When fuses are used in a product, replace with the same type and rating for continued protection against fire hazard.

Chassis connections must only be used as shield connections for measuring circuits, NOT as safety earth ground connections.

If you are using a test fixture, keep the lid closed while power is applied to the device under test. Safe operation requires the use of a lid interlock.

If a  screw is present, connect it to safety earth ground using the wire recommended in the user documentation.

The  symbol on an instrument means caution, risk of danger. The user should refer to the operating instructions located in the user documentation in all cases where the symbol is marked on the instrument.

The  symbol on an instrument means caution, risk of danger. Use standard safety precautions to avoid personal contact with these voltages.

The  symbol on an instrument shows that the surface may be hot. Avoid personal contact to prevent burns.

The  symbol indicates a connection terminal to the equipment frame.

If this  symbol is on a product, it indicates that mercury is present in the display lamp. Please note that the lamp must be properly disposed of according to federal, state, and local laws.

The **WARNING** heading in the user documentation explains dangers that might result in personal injury or death. Always read the associated information very carefully before performing the indicated procedure.

The **CAUTION** heading in the user documentation explains hazards that could damage the instrument. Such damage may invalidate the warranty.

Instrumentation and accessories shall not be connected to humans.

Before performing any maintenance, disconnect the line cord and all test cables.

To maintain protection from electric shock and fire, replacement components in mains circuits - including the power transformer, test leads, and input jacks - must be purchased from Keithley Instruments. Standard fuses with applicable national safety approvals may be used if the rating and type are the same. Other components that are not safety-related may be purchased from other suppliers as long as they are equivalent to the original component (note that selected parts should be purchased only through Keithley Instruments to maintain accuracy and functionality of the product). If you are unsure about the applicability of a replacement component, call a Keithley Instruments office for information.

To clean an instrument, use a damp cloth or mild, water-based cleaner. Clean the exterior of the instrument only. Do not apply cleaner directly to the instrument or allow liquids to enter or spill on the instrument. Products that consist of a circuit board with no case or chassis (e.g., a data acquisition board for installation into a computer) should never require cleaning if handled according to instructions. If the board becomes contaminated and operation is affected, the board should be returned to the factory for proper cleaning/servicing.

# Table of Contents

---

Topic	Page
Introduction .....	1-2
Source-measure capabilities .....	1-2
Front and rear panels .....	1-3
Navigating menus and entering numeric data .....	1-4
Menu navigation .....	1-4
Numeric data entry (EDIT keys) .....	1-4
Editing source and compliance values .....	1-4
Editing keys .....	1-4
Editing procedure .....	1-5
Toggling the source and measure display fields .....	1-5
Basic connections .....	1-6
Front/rear terminals selection .....	1-6
2-wire connections .....	1-6
4-wire connections .....	1-7
Cable guard .....	1-8
Ohms guard .....	1-9
Remote command programming .....	1-10
Basic SourceMeter operations .....	1-10
Source-measure .....	1-10
Measure only (V or I) .....	1-11
Measure ohms .....	1-12
Remote command programming .....	1-14
Settings to optimize performance .....	1-17
Range .....	1-17
Speed .....	1-18
Digits .....	1-18
Filter .....	1-18
Rel (nulling offsets) .....	1-19
Remote command programming .....	1-20
Features to enhance DUT testing .....	1-20
Data store .....	1-20
Sweep operation .....	1-22
Performing sweeps .....	1-26
Limit testing .....	1-30
Math functions .....	1-33
Pulse mode (Model 2430 only) .....	1-36

**Quick start topics**

Topic	Page
Introduction .....	1-1
Source-measure capabilities .....	1-2
Front and rear panels .....	1-3
Navigating menus and entering numeric data .....	1-4
Editing source and compliance values .....	1-4
Basic connections .....	1-6
Basic SourceMeter operations .....	1-10
Settings to optimize performance .....	1-17
Features to enhance DUT testing .....	1-20

## Introduction

This guide is designed to familiarize users with fundamental operation (front panel and remote) of the Keithley 2400 Series SourceMeters. For comprehensive information on all aspects of SourceMeter operation, refer to the 2400 Series SourceMeter User's Manual.

Operation information in this guide is divided into four parts; (1) Fundamental source-measure operations, (2) Settings to optimize performance, (3) Features to enhance DUT testing and (4) More testing techniques. This format allows a new user to easily progress from basic simple operation to more complex procedures.

**Remote command programming** - For the various SourceMeter operating modes covered in this guide, the related SCPI commands for remote operation are summarized in tables. Most commands have a query form. For example, :OUTPut ON turns the output on, while :OUTPut? requests the present state of the output. Note that the SourceMeter must be addressed to talk after sending a query command.

For operations where command sequence is important, programming examples are provided. The exact programming syntax will depend on the test program language.

## Source-measure capabilities

### Model 2400:

- Source voltage from 5 $\mu$ V to 210V; measure voltage from 1 $\mu$ V to 211V.
- Source current from 50pA to 1.05A; measure current from 10pA to 1.055A.
- Measure resistance from 100 $\mu\Omega$  (<100 $\mu\Omega$  in manual ohms) to 211M $\Omega$
- Maximum source power is 22W.

### Model 2400-LV and 2401:

- Source voltage from 5 $\mu$ V to 21V; measure voltage from 1 $\mu$ V to 21V.
- Source current from 50pA to 1.05A; measure current from 10pA to 1.055A.
- Measure resistance from 100 $\mu\Omega$  (<100 $\mu\Omega$  in manual ohms) to 211M $\Omega$
- Maximum source power is 22W.

---

NOTE The Model 2401 does not use the digital output lines of the Digital I/O port. Therefore, it cannot be used with a component handler to perform binning operations.

---

### Model 2410:

- Source voltage from 5 $\mu$ V to 1100V; measure voltage from 1 $\mu$ V to 1100V.
- Source current from 50pA to 1.05A; measure current from 10pA to 1.055A.
- Measure resistance from 100 $\mu\Omega$  (<100 $\mu\Omega$  in manual ohms) to 211M $\Omega$
- Maximum source power is 22W.

### Model 2420:

- Source voltage from 5 $\mu$ V to 63V; measure voltage from 1 $\mu$ V to 63.3V.
- Source current from 500pA to 3.15A; measure current from 100pA to 3.165A.
- Measure resistance from 10 $\mu\Omega$  (<10 $\mu\Omega$  in manual ohms) to 21.1M $\Omega$
- Maximum source power is 66W.

**Model 2425:**

- Source voltage from 5 $\mu$ V to 105V; measure voltage from 1 $\mu$ V to 105.5V.
- Source current from 500pA to 3.15A; measure current from 100pA to 3.165A.
- Measure resistance from 10 $\mu\Omega$  (<10 $\mu\Omega$  in manual ohms) to 21.1M $\Omega$
- Maximum source power is 110W.

**Model 2430:**

- Source DC or pulse voltage from 5 $\mu$ V to 105V; measure voltage from 1 $\mu$ V to 105.5V.
- Source DC current from 500pA to 3.15A; measure DC current from 100pA to 3.165A.
- Source pulse current from 500pA to 10.5A; measure pulse current from 100pA to 10.55A.
- Measure resistance from 10 $\mu\Omega$  (<10 $\mu\Omega$  in manual ohms) to 21.1M $\Omega$
- Maximum DC source power is 110W.
- Maximum pulse source power is 1.1kW.

**Model 2440:**

- Source voltage from 5 $\mu$ V to 42V; measure voltage from 1 $\mu$ V to 42V.
- Source current from 500pA to 5.25A; measure current from 100pA to 5.25A.
- Measure resistance from 10 $\mu\Omega$  (< 10 $\mu\Omega$  in manual ohms) to 21.1 M $\Omega$ .
- Maximum source power is 55W.

## Front and rear panels

The front and rear panels of the Model 2400 SourceMeter are shown in Figures 1 and 2. The front and rear panels of the other SourceMeter models are similar. The use of the various instrument controls and connectors will be explained throughout this guide.

Figure 1-1  
Front Panel



Figure 1-2  
Rear Panel

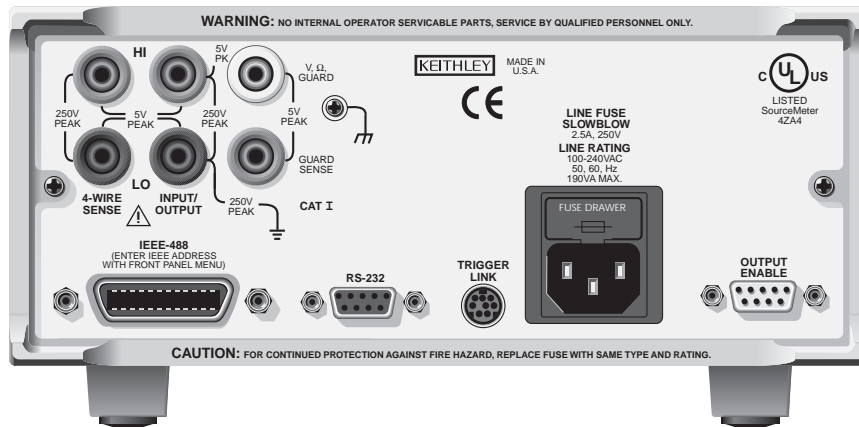

## Navigating menus and entering numeric data

### Menu navigation

Many operating modes for the SourceMeter are configured using front panel menus. Throughout this guide, menu navigation will be presented as a sequence of key presses and menu item selections. For example, the following sequence selects the auto ohms source mode:

Press CONFIG > press MEAS Ω > select SOURCE > select AUTO

The above sequence is explained as follows:

1. Press the CONFIG key.
2. Press the MEAS Ω key.
3. Select the SOURCE menu item.
4. Select the AUTO ohms source mode.

A menu item is selected by placing the cursor on it and pressing the ENTER key. The left and right arrow keys control cursor position.

### Numeric data entry (EDIT keys)

Numeric values must be entered for some menu items. Numeric entry is also used to set source and compliance values. The edit keys for numeric entry include the EDIT arrow keys to control cursor position, EDIT arrow keys to increment or decrement the digit value, and the number keys.

After a value is keyed in, press ENTER to select it. Note that pressing MENU resets a displayed number to its minimum value.

## Editing source and compliance values

### Editing keys

Use the following keys to edit source and compliance values:



- DISPLAY EDIT — Selects the source or compliance display field for editing. A blinking cursor will appear in the field to be edited. If no key is pressed within a few seconds, the edit mode will be cancelled automatically.
- EDIT arrow keys — Places the display cursor on the display digit to be changed.
- SOURCE arrow keys — Increments or decrements the source or compliance value. Note that pressing either of these keys will automatically enable the source edit mode.
- RANGE arrow keys — Selects the source or compliance range.
- Numeric keys (0-9) — Allow you to directly enter source or compliance values.
- EXIT — Exits the edit mode without waiting for the time-out period.

## Editing procedure

1. Press the DISPLAY EDIT key to place the blinking cursor in either the source or compliance display field to be edited.
2. If desired, use the RANGE arrow keys to select the desired source or compliance range.
3. To simply increment or decrement the display value, use the EDIT arrow keys to place the blinking cursor on the digit to be changed, then increment or decrement the value with the SOURCE arrow keys. Note that the source or compliance value will be updated immediately; you need not press ENTER to complete the process.
4. To enter the source or compliance value directly, simply key in the desired value with the numeric keys while the cursor is blinking. Again, the source or compliance value will be updated immediately.

## Toggling the source and measure display fields

Normally, the measured reading value will appear in the upper, main display line, while the source and compliance values will appear in the left and right fields respectively of the lower display line. You can toggle the source and measure display fields by pressing the DISPLAY TOGGLE key to place the source and measure values in the desired display fields.

## Basic connections

---

---

**WARNING** *The SourceMeter uses safety jacks for signal connections. To avoid electric shock:*

- *Do not leave exposed connections.*
  - *Properly insulate all external circuits.*
  - *The front and rear terminals of the SourceMeters are rated for connection to circuits rated Installation Category I only. Do not connect the SourceMeter terminals to CAT II, CAT III, or CAT IV circuits. Connection of the SourceMeter Input/Output terminals, to circuits higher than CAT I, can cause damage to the equipment or expose the operator to hazardous voltages.*
  - *Hazardous voltages may be present on the output and guard terminals. To prevent electrical shock that could cause injury or death, NEVER make or break connections to the SourceMeter while the unit is on. Power off the equipment from the front panel or disconnect the main power cord from the rear of the SourceMeter before handling cables connected to the outputs. Putting the equipment into standby mode does not guarantee the outputs are not powered if a hardware or software fault occurs.*
- 
- 

The three basic connection configurations for the SourceMeter include 2-wire local sensing, 4-wire remote sensing, and cable guard.

---

**NOTE** Connections and details for in-circuit ohms measurements (ohms guard) are covered in the “Advanced operation” section of this guide.

---

### Front/rear terminals selection

The input/output and sense terminals are accessible from both the front and rear panels, while the guard terminals and chassis ground are only accessible from the rear panel. On the front panel, press the FRONT/REAR key to toggle between front and rear. The REAR annunciator indicates that the rear terminals are selected. With REAR off, the front terminals are selected.

### 2-wire connections

Connections for 2-wire local sensing are shown in Figure 3. The following menu sequence selects 2-wire local sensing:

Press CONFIG > select SOURCE V (or MEAS  $\Omega$ ) > select SENSE MODE > select 2-WIRE

Figure 1-3  
2-wire connections

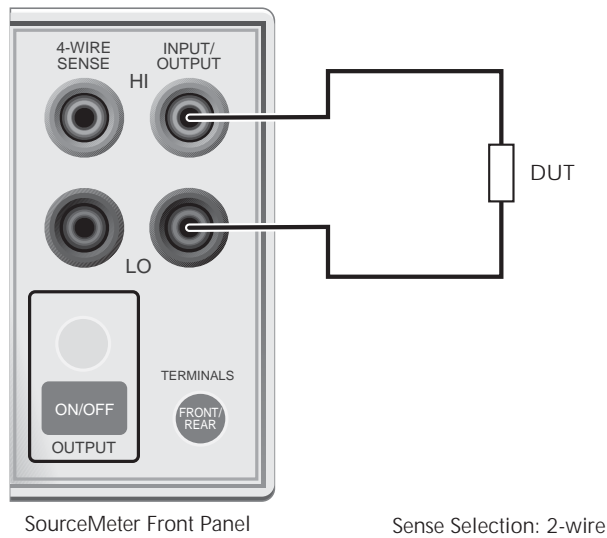
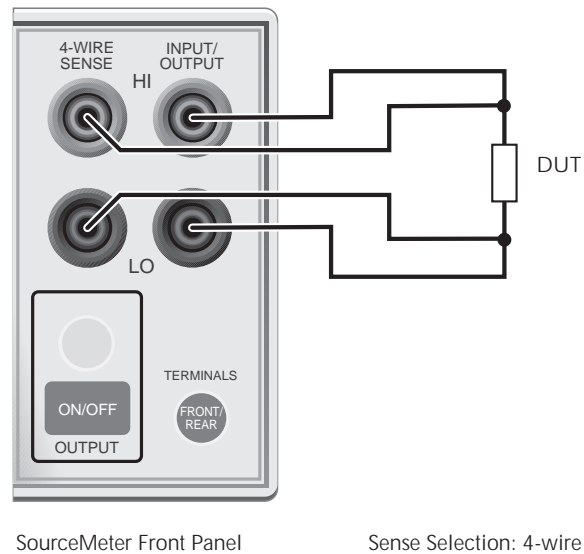

Figure 1-4  
4-wire connections



## 4-wire connections

Connections for 4-wire local sensing are shown in Figure 4. Use 4-wire remote sensing for the following source-measure conditions:

- Test circuit impedance is  $<1\text{k}\Omega$
- Optimum ohms, V-source, and/or V-measure accuracy is required.

With 4-wire sensing selected, the 4W annunciator is on. The following menu sequence selects 4-wire remote sensing:

Press CONFIG > select SOURCE V (or MEAS  $\Omega$ ) > select SENSE MODE > select 4-WIRE

---

**NOTE** Specified accuracies for both source and measure are achieved only using 4-wire remote sensing.

---

## Cable guard

When testing high-impedance DUT ( $>1\text{G}\Omega$ ), cable guard is used to drive the shields of cables and test fixtures to minimize leakage currents and input capacitance. A typical connection scheme using cable guard is shown in Figure 5. The following menu sequence selects cable guard:

Press CONFIG > press SOURCE V (or SOURCE I or MEAS  $\Omega$ ) > select GUARD > select CABLE

The guard terminal of the SourceMeter is at virtually the same potential as input/output HI. Therefore, if there is hazardous voltage at input/output HI, it is also present on the guard shield for the test circuit.

---

**WARNING** To prevent injury from electric shock, the guard shield must be enclosed in a safety shield (i.e., test fixture) that is connected to safety earth ground (as shown in Figure 5).

---

**Figure 1**  
Cable guard connections

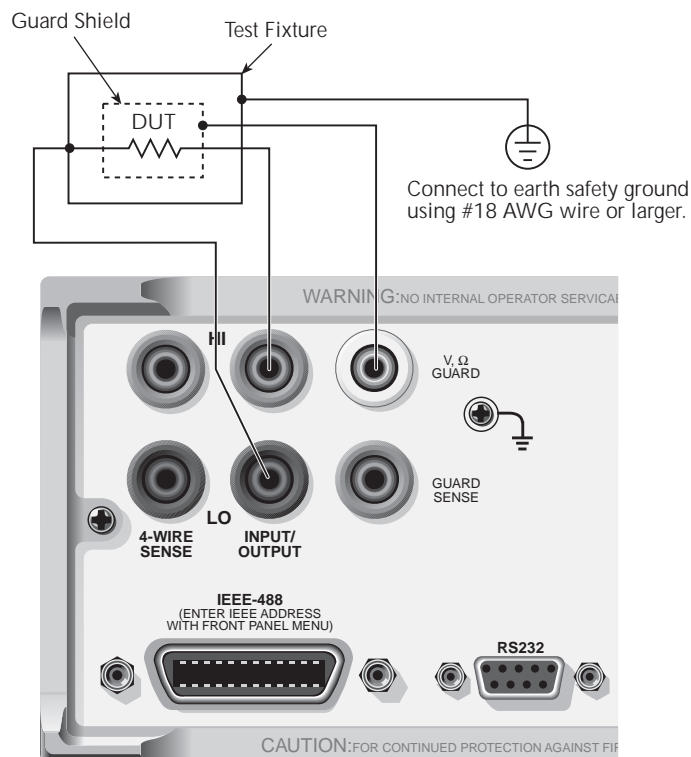
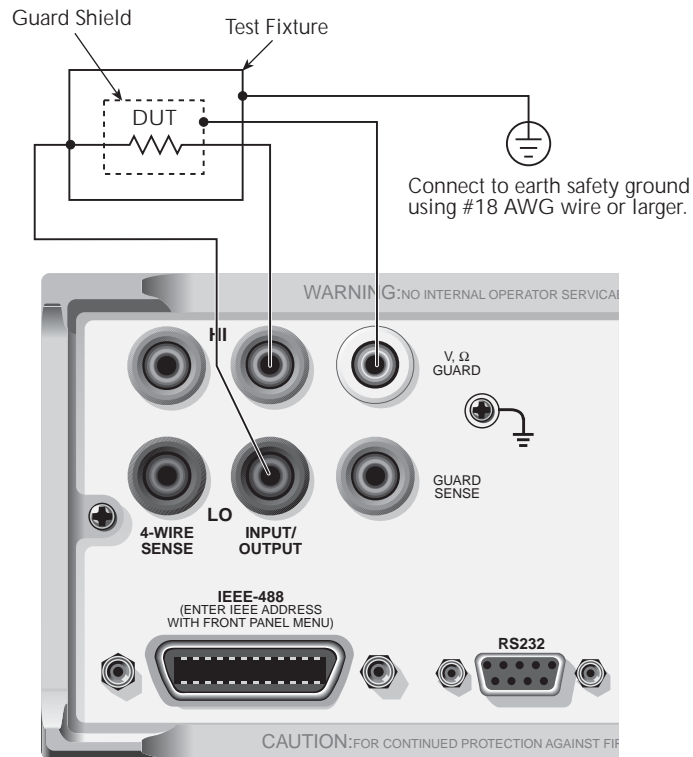

Figure 1-5  
Cable guard connections



## Ohms guard

Ohms guard allows in-circuit resistance measurements on DUT where other parasitic leakage devices are present. Connection schemes for a Delta DUT configuration is shown in Figure 6.

---

**NOTE** Ohms guard cannot be used for high current (>100mA) ranges.  
Ohms guard cannot be selected if already on a high current range.  
Conversely, if ohms guard is already selected, a high current range cannot be selected.

---

The following menu sequence selects ohms guard:

Press CONFIG > press MEAS  $\Omega$  (or SOURCE V or SOURCE I) > select GUARD > select OHMS

Basic connections for ohms guard is shown in Figure 6A. With V,  $\Omega$  Guard and In/Out HI at virtually the same potential, the voltage drop across R will be 0V, and therefore, the current through R will be 0A. Virtually all the current from In/Out HI will flow through the DUT resulting in an accurate measurement.

If the guard resistance path ( $R_G$ ) is  $<1k\Omega$ , IR drop in the V,  $\Omega$  Guard test lead could be high enough such that a significant voltage drop appears across R. The resultant leakage current through R will corrupt the measurement of the DUT.

Guard Sense is used to cancel the effect of IR drop in the V,  $\Omega$  Guard test lead as shown in Figure 6B. Guard Sense regulates the guard voltage to ensure that the same potential appears on either side of R.

For DUT  $<1k\Omega$ , 4-wire sensing should be used as shown in Figure 6C.

**NOTE** Guard current ( $I_G$ ) must never exceed 50mA. If it does, guard voltage will become less than the output voltage and corrupt the measurement.

**Figure 1-6**  
**Guarded ohms measurements**

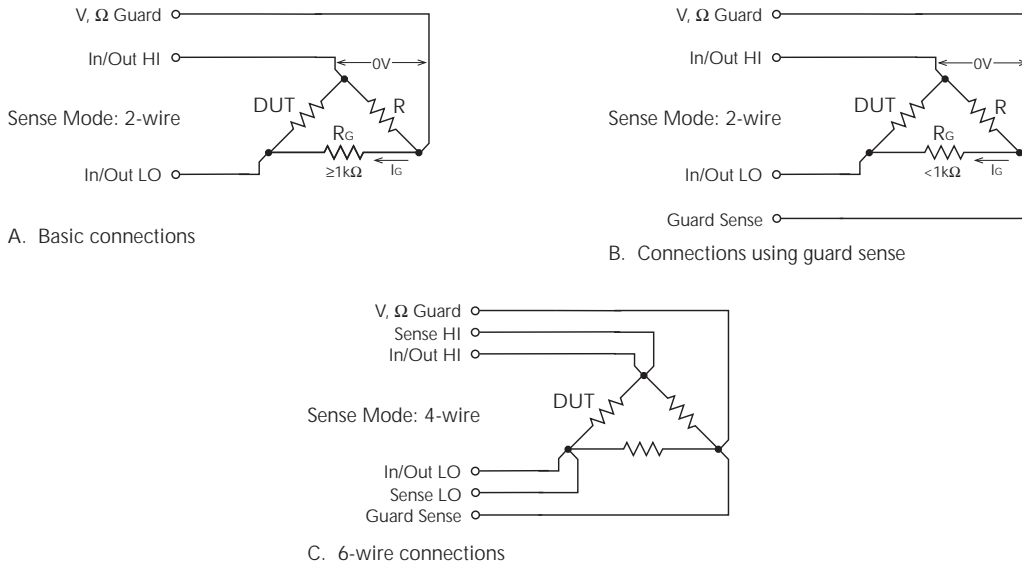

### Remote command programming

Table 1 lists the SCPI commands to select terminals, sense, and cable guard.

Table 1-1

**SCPI commands; terminals, sense, and cable guard**

Command	Description
:ROUTe:TERMinals <name>	Selects terminals; <name> = FRONT or REAR.
:SYSTem:RSENse <b>	Selects sense mode; <b> = ON (4-wire) or OFF (2-wire).
:SYSTem:GUARd <name>	Selects guard mode; <name> = CABLE or OHMS.

### Basic SourceMeter operations

Fundamental SourceMeter operations include source-measure, measure only (V or I) and measure ohms.

#### Source-measure

There are four source-measure combinations for the SourceMeter:

- Source V, Measure I
- Source I, Measure V
- Source V, Measure V
- Source I, Measure I

The basic procedure to source-measure is provided in Table 2. It assumes that the DUT is already connected to the SourceMeter as explained in *Basic connections*.

Table 1-2  
**Source-measure procedure**

Procedure	Details
1. Select source function.	Press SOURCE V or SOURCE I.
2. Set source level.	Use DISPLAY EDIT key to place cursor in source field (Vsrc or Isrc), use RANGE arrow keys to select range, use edit keys to key in source value, then press ENTER.
3. Set compliance limit.	Use DISPLAY EDIT key to place cursor in Cmpl field, use RANGE arrow keys to select range, use edit keys to key in limit value, then press ENTER.
4. Select measurement function.	Press MEAS V or MEAS I.
5. If not measuring the source, select measure range or use auto range (see Notes 1 and 2).	Use RANGE arrow keys to manually select range. Or press AUTO RANGE (AUTO annunciator on) to enable auto range.
6. Turn output on and take readings from display.	Press ON/OFF OUTPUT key. Red OUTPUT indicator on.
7. Turn output off when finished.	Press ON/OFF OUTPUT key. Red OUTPUT indicator off.

Notes:

1. When measuring source (i.e., Source I, Measure I), you cannot change the measure range or enable auto range. The measure range is determined by the source range.
2. When not measuring the source (i.e., Source I, Measure I), the compliance range determines the maximum measurement range that can be selected.

### Sink operation

When operating as a sink (V and I have opposite polarity), the SourceMeter is dissipating power rather than sourcing it. An external source can force operation into the sink region. The SourceMeter can be used to charge/discharge (source/sink) batteries. For operation information on battery charging/discharging (and the associated precautions), see Section 3, *Sink operation* of the 2400 Series SourceMeter User's Manual.

### Measure only (V or I)

The SourceMeter can be used to measure voltage only (voltmeter) or current only (ammeter). The procedure to measure only is provided in Table 3.

Table 1-3  
**Measure only (V or I) procedure**

Procedure	Details
1. Select source-measure functions.	To measure voltage, press SOURCE I and MEAS V. To measure current, press SOURCE V and MEAS I.
2. Set source level to zero.	Use DISPLAY EDIT key to place cursor in source field (Vsrc or Isrc), use RANGE down arrow key to select lowest range, press MENU to display zero source level, then press ENTER.
3. Set compliance higher than the expected measurement (see CAUTION 1).	Use DISPLAY EDIT key to place cursor in Cmpl field, use RANGE arrow keys to select range, use edit keys to key in compliance value, then press ENTER.
4. Select measurement range (see Note).	Use RANGE arrow keys to select a fixed measurement range. For best accuracy, use the lowest possible range.
5. Connect voltage or current to be measured.	Connect DUT to SourceMeter using 2-wire connections (see Figure 3).
6. Turn output on and take reading from display.	Press ON/OFF OUTPUT key. Red OUTPUT indicator on.
7. Turn output off when finished.	Press ON/OFF OUTPUT key. Red OUTPUT indicator off.

Note:When measuring current, auto range can be used. When measuring voltage, DO NOT use auto range (see CAUTION 2).

---

**CAUTION** When using the SourceMeter as a voltmeter only, voltage compliance must be set higher than the voltage that is being measured. Failure to do so could result in instrument damage due to excessive current that will flow into the SourceMeter.

---



---

**CAUTION** When using the SourceMeter as a voltmeter only, DO NOT use auto range and NEVER select a measurement range that is below the applied signal level. Otherwise, high current drawn from the external source could damage the external source or the test circuit.

---

## Measure ohms

### Measurement methods

There are two methods to measure resistance; auto ohms and manual ohms. In auto ohms, the SourceMeter operates as a conventional constant-current source ohmmeter. You simply select an ohms measurement range (or auto range) and take the reading from the display.

In manual ohms, the SourceMeter uses the V/I measurement method. After configuring the source (V or I) and selecting a voltage or current measurement range, the  $\Omega$  measurement function will display the calculated V/I ohms reading.



Use the following menu sequence to select the auto ohms or manual ohms measurement method:

Press CONFIG > press MEAS  $\Omega$  > select SOURCE > select AUTO or MANUAL

### Ohms source readback

With source readback enabled, the SourceMeter measures both V and I and uses these values for the ohms calculation. This feature provides optimum accuracy for front panel operation since the measured source value is more accurate than the programmed source value. For remote operation, the user specifies the functions to measure.

Use the following menu sequence to enable or disable source readback:

Press CONFIG > press MEAS  $\Omega$  > select SRC RDBK > select ENABLE or DISABLE

### Ohms measurement procedures

The auto ohms and manual ohms measurement procedures are provided in Tables 4 and 5. They assume that the DUT is already connected to the SourceMeter. (See *Basic connections*.) Note that resistance accuracy specifications are based on 4-wire sensing.

Table 1-4

#### Auto ohms measurement procedure

Procedure	Details
1. Select ohms measurement function.	Press MEAS $\Omega$
2. Select auto ohms measurement method.	Press CONFIG > press MEAS $\Omega$ > select SOURCE > select AUTO.
3. Select measurement range.	Use RANGE arrow keys to manually select range. Or press AUTO RANGE (AUTO annunciator on) to enable auto range.
4. Turn output on and take readings from display.	Press ON/OFF OUTPUT key. Red OUTPUT indicator on.
5. Turn output off when finished.	Press ON/OFF OUTPUT key. Red OUTPUT indicator off.

Table 1-5

#### Manual ohms measurement procedure

Procedure	Details
1. Select ohms measurement function.	Press MEAS $\Omega$
2. Select manual ohms measurement method.	Press CONFIG > press MEAS $\Omega$ > select SOURCE > select MANUAL.
3. Select source, set source level, and set compliance limit.	See steps 1, 2, and 3 of Table 2.
4. Select measurement range (see Notes 1 and 2).	Use RANGE arrow keys to manually select range. Or press AUTO RANGE (AUTO annunciator on) to enable auto range.
5. Turn output on and take readings from display.	Press ON/OFF OUTPUT key. Red OUTPUT indicator on.
6. Turn output off when finished.	Press ON/OFF OUTPUT key. Red OUTPUT indicator off.

#### Notes

1. If sourcing I, you will be selecting the V measure range. If sourcing V, you will be selecting the I measure range.
2. The compliance range determines the maximum measurement range that can be selected.

## Offset-compensated ohms

Thermal EMFs can corrupt low-resistance measurements. An offset-compensated  $\Omega$  measurement cancels out unwanted offset by performing the following 2-point measurement process:

$$\text{Offset-Compensated } \Omega = \Delta V / \Delta I$$

$$\text{where: } \Delta V = V2 - V1$$

$$\Delta I = I2 - I1$$

V1 and I1 are V and I measurements with the source set to a specific level.

V2 and I2 are V and I measurements with the source set to zero.

1. Select the  $\Omega$  function, and select the auto or manual ohms measurement method.
2. Enable offset compensation by using the following menu sequence:
3. Press CONFIG > press MEAS  $\Omega$  > select OFFSET COMPENSATION > select ENABLE
4. If using auto ohms, go to the next step. For manual ohms, configure the desired source (V or I) to output an appropriate source level. Set compliance and select a measurement range (or use auto range).
5. Turn the output on and observe the offset-compensated ohms reading on the display. Note that the source value alternates between the set output level and zero.
6. When finished, turn the output off and disable offset compensation.

---

NOTE Manual offset-compensated ohms is also available as a math function (FCTN). This math function allows you to specify both source levels (see “Math functions” in “Features to enhance DUT testing.”)

---

## In-circuit ohms measurements

Ohms guard allows you make accurate in-circuit ohms measurements on resistor networks. These measurements are covered in *Advanced operation*.

## Remote command programming

### Data string

The :READ? command is typically used to trigger a source-measure action and request the data string. The data string is sent to the computer when the SourceMeter is addressed to talk.

The data string is typically made up of five elements separated by commas. The first element is the voltage reading, the second is the current reading, and the third is the resistance reading. For voltage and current, the reading could be source or measure depending on how the instrument is configured. For example, if sourcing voltage and measuring current, the voltage element is the source reading and the current element is the measured reading. The NAN (not a number) value of +9.91e37 is used for a function that is not enabled.

The fourth data element is the timestamp and the fifth is the status word. See Section 18, *FORMat subsystem*, of the 2400 Series SourceMeter User’s Manual for details on all aspects of the data format.

---

NOTE The five element data string is the GPIB default condition.

---

## SCPI commands

SCPI commands to source-measure and measure only are provided in Table 6, and the commands to measure ohms are provided in Table 7.

Table 1-6

### SCPI commands; source-measure and measure only <sup>1</sup>

Command <sup>2</sup>	Description
:SOURce:FUNcTion <name>	Select source function; <name> = VOLTage or CURRent.
:SOURce:xxx:MODE FIXed	Select fixed V or I sourcing mode.
:SOURce:xxx:RANGe <n>	Select measurement range for V or I source; <n> = range.
:SOURce:xxx:LEVel <n>	Set source amplitude; <n> = amplitude in volts or amps.
[:SENSe]:FUNcTion <name>	Select measure function; <name> = "VOLTage" or "CURRent".
[:SENSe]:xxx:PROTection <n>	Set V or I compliance; <n> = compliance.
[:SENSe]:xxx:RANGe <n>	Select V or I measure range; <n> = range.
[:SENSe]:xxx:RANGe:AUTO <b>	Enable or disable auto range; <b> = ON or OFF.
:OUTPut <b>	Turn output on or off; <b> = ON or OFF.
:READ?	Trigger and acquire one data string.

- For measure only, the following rules apply (Table 9 provides an example to measure I only):
  - To measure V only, you must source I. To measure I only, you must source V.
  - The source must be set to 0V or 0A.
  - When measuring V only, DO NOT use auto range.
  - When measuring V only, voltage compliance MUST be set higher than the voltage being measured.
- :xxx = :VOLTage or :CURRent.

Table 1-7

### SCPI commands; measure ohms

Command	Description
[:SENSe]:FUNcTion "RESistance"	Select ohms function.
[:SENSe]:RESistance:MODE <name>	Select ohms mode; <name> = AUTO or MANual*.
[:SENSe]:RESistance:OCOMpensated <b>	Enable/disable offset compensation.
[:SENSe]:RESistance:RANGe <n>	Select range for auto ohms; <n> = range.
[:SENSe]:RESistance:RANGe:AUTO <b>	Enable or disable auto range for auto ohms; <b> = ON or OFF.
:OUTPut <b>	Turn output on or off; <b> = ON or OFF.
:READ?	Trigger and acquire one data string.

\*For manual ohms, you must configure the SourceMeter to source-measure. Table 11 provides a programming example to measure ohms using the manual ohms method.

## Programming examples

**Source-measure example** — Table 8 shows a typical command sequence to source 10V and measure current on the 10mA range.

**Measure-only example** — Table 9 shows a typical command sequence to measure current only.

Table 1-8

**Command sequence for source-measure example**

Command*	Comments
*RST	Restore GPIB defaults (one-shot source-measure mode).
:SOUR:FUNC VOLT	Select voltage source function.
:SOUR:VOLT:MODE FIX	Select fixed voltage source mode.
:SOUR:VOLT:RANG 20	Select 20V source range.
:SOUR:VOLT:LEV 10	Set source output level to 10V.
:SENS:FUNC "CURR"	Select current measurement function.
:SENS:CURR:PROT 10e-3	Set compliance limit to 10mA.
:SENS:CURR:RANG 10e-3	Select the 10mA measurement range.
:OUTP ON	Turn the output on.
:READ?	Trigger and acquire one data string.

\*SourceMeter must be addressed to talk after sending :READ? to trigger and acquire data.

Table 1-9

**Command sequence for measure current only example**

Command*	Comments
*RST	Restore GPIB defaults (one-shot measure mode).
:SOUR:FUNC VOLT	Select voltage source function.
:SOUR:VOLT:MODE FIX	Select fixed voltage source mode.
:SOUR:VOLT:RANG 0.2	Select 200mV source range.
:SOUR:VOLT:LEV 0	Set source output level to 0.000mV.
:SENS:FUNC "CURR"	Select current measurement function.
:SENS:CURR:PROT 100e-3	Set compliance limit to 100mA.
:SENS:CURR:RANG 10e-3	Select the 10mA measurement range.
:OUTP ON	Turn the output on.
:READ?	Trigger and acquire one data string.

\*SourceMeter must be addressed to talk after sending :READ? to trigger and acquire data.

**Auto ohms example** — Table 10 shows a typical command sequence to use auto ohms to measure resistance. Note that 4-wire sensing is used for this example. See Basic connections for details on sensing.

**Manual ohms example** — Table 11 shows a typical command sequence to use manual ohms to measure resistance. This example uses auto range for current measurements. If you were to use manual ranging, you should select the lowest possible current range for the measurement. For example, to measure a 1MΩ resistor with the source set to 2V, the 1μA measure range should be selected to achieve the best accuracy ( $2V/1\mu A = 2M\Omega$ ). Note that 2-wire sensing is used for this example. See Basic connections for details on sensing.

Table 1-10  
**Command sequence for auto ohms example**

Command*	Comments
*RST	Restore GPIB defaults (one-shot measurement mode).
:SENS:FUNC "RES"	Select ohms measurement function.
:SENS:RES:RANG 200	Select 200Ω range.
:SENS:RES:MODE AUTO	Select the auto ohms measurement method.
:SYST:RSEN ON	Select 4-wire sense mode.
:OUTP ON	Turn the output on.
:READ?	Trigger and acquire one data string.

\*SourceMeter must be addressed to talk after sending :READ? to trigger and acquire data.

Table 1-11  
**Command sequence for manual ohms example**

Command*	Comments
*RST	Restore GPIB defaults (one-shot measurement mode).
:SENS:FUNC "RES"	Select ohms measurement function.
:SENS:RES:MODE MAN	Select the manual ohms measurement method.
:SOUR:FUNC VOLT	Select voltage source function.
:SOUR:VOLT:MODE FIX	Select fixed voltage sourcing mode.
:SOUR:VOLT:RANG 2	Select 2V source range.
:SOUR:VOLT:LEV 2	Set source level to 2V.
:SENS:CURR:PROT 10e-3	Set current compliance to 10mA.
:SENS:CURR:RANG:AUTO ON	Select auto range for current measurements.
:SYST:RSEN OFF	Select 2-wire sense mode.
:OUTP ON	Turn the output on.
:READ?	Trigger and acquire one data string.

\*SourceMeter must be addressed to talk after sending :READ? to trigger and acquire data.

## Settings to optimize performance

### Range

To achieve best accuracy, the SourceMeter should be on the lowest possible measurement range. In most situations, auto range can be used to automatically select the best range. Auto range is controlled (enabled/disabled) by the AUTO range key (AUTO annunciator indicates auto range is enabled).

RANGE arrow keys are used for manual range selection. Note that pressing either of these keys disables auto range.

---

NOTE Basic ranging information (including the SCPI commands for remote operation) is covered in "Fundamental source-measure operations."

---

## Speed

Measurement speed is set by setting the integration time of the A/D converter (period of time the input signal is measured). Integration time affects the usable digits, reading noise, and the ultimate reading rate of the instrument. It is specified in parameters based on the number of power line cycles (NPLC), where 1 PLC for 60Hz is 16.67msec (1/60), and 1 PLC for 50Hz and 400Hz is 20msec (1/50).

In general, the fastest speed setting (FAST; 0.01 PLC) results in increased noise and fewer usable display digits. The slowest speed (HI ACCURACY; 10 PLC) provides the best common-mode and normal-mode noise rejection. In between settings are a compromise between speed and noise.

Press SPEED and select one of the following speed setting options:

FAST	Sets speed to 0.01 PLC and display resolution to 3½digits.
MED	Sets speed to 0.10 PLC and display resolution to 4½digits.
NORMAL	Sets speed to 1.00 PLC and display resolution to 5½digits.
HI ACCURACY	Sets speed to 1.00 PLC and display resolution to 5½digits.
OTHER	Use to set speed to any PLC value from 0.01 to 10. Display resolution is not changed after speed is set with this option.

---

NOTE After setting speed, display resolution can be changed using the DIGITS key.

---

## Digits

The SourceMeter can display readings at 3½digit, 4½digit, 5½digit or 6½digit resolution. In situations where the last digits of the reading are noisy, you can turn those digits off by decreasing display resolution.

To set display resolution, press the DIGITS key until the desired number of digits are displayed. Another way to set display resolution is with the following menu sequence:

Press CONFIG > press DIGITS > select 3.5, 4.5, 5.5, or 6.5.

---

NOTE Changing DIGITS does not affect measurement SPEED, but changing measurement speed does affect DIGITS.

---

## Filter

Filtering is used to stabilize noisy readings. In general, the more filtering that is applied, the more stable (and accurate) the reading. However, more filtering also means slower speed.

The filtering process consists of filling a stack with the specified number of reading conversions (filter count), and then averaging them to yield a filtered reading. The SourceMeter has two filter types; moving and repeating.

### Repeating filter

The stack is filled with the specified number of reading conversions. The reading conversions are averaged to yield a filtered reading. The stack is then cleared, and the process starts over. Use this filter for sweeping so readings for other source levels are not averaged with the present source level.

## Moving filter

The first reading conversion is placed in the stack, and is copied to the other stack locations to fill it. Therefore, the first filtered reading is the same as the first reading conversion. The stack type is first-in, first-out. Each subsequent conversion replaces one of the copied readings in the stack, which is then averaged to yield the next filtered reading. Note that as this process continues, a true average is not yielded until the stack is filled with new reading conversions (no copies in stack).

Once the stack is filled, each subsequent conversion placed into the stack replaces the oldest conversion. The stack is re-averaged, yielding a new filtered reading.

## Response time

Filter type and count have the following effects on the time needed to display, store, or output a filtered reading:

- Filter type: The moving filter type yields faster filtered readings since it doesn't have to re-fill the entire stack (as is the case for the repeating filter).
- Filter count: Speed and accuracy are trade-offs. Typically, you will want to apply just enough filtering to achieve acceptably stable readings.

## Filter configuration

**Filter type** — Use the following menu sequence to select filter type:

Press CONFIG > press FILTER > select AVERAGE MODE > select MOVING or REPEAT

**Filter count** — Use the following menu sequence to select the amount of filtering:

Press CONFIG > press FILTER > select AVERAGE COUNT, set count value (1 to 100)

## Rel (nulling offsets)

The rel (relative) feature allows you to null offsets. With the offset displayed (measured), enabling rel acquires the offset reading as the rel value and zeroes the display as follows:

Displayed Reading = Actual Input - Rel Value

Since the actual input (offset) and the rel value are the same, the displayed reading is zero.

Rel is enabled by pressing the REL key (REL annunciator on). Pressing REL a second time disables it. Perform the following steps to null out an offset:

1. Connect your test circuit to the SourceMeter.
2. Select the source function that you are going to use for your test.
3. Select the lowest source range and set the source level to zero.
4. Select the measure function that you are going to use for your test, and select the lowest range.
5. Turn the output on to measure the offset.
6. With the offset reading displayed, press REL (REL annunciator on) to zero the display. Turn the output off and configure the selected source and measure functions for your test.
7. Turn the output back on. The displayed test readings will not include the nulled offset.
8. When finished, turn the output off.

If the offset drifts, disable rel and repeat the above procedure to null out the new offset.

---

**NOTE** Rel can also be used to establish a baseline reading. The baseline reading will be subtracted from present and future readings. See “Relative” in Section 8 of the 2400 Series SourceMeter User’s Manual for details.

---

## Remote command programming

The SCPI commands for speed, digits, filter, and rel are listed in Table 12. The commands for ranging are listed in Tables 6 and 7.

Table 1-12

**SCPI commands; speed, digits, filter, and rel**

Command	Description
<i>Speed commands</i> <sup>1</sup> :	
[:SENSe]:CURRent:NPLCycles <n>	Set measurement speed; <n> = 0.01 to 10.
[:SENSe]:VOLTage:NPLCycles <n>	Set measurement speed; <n> = 0.01 to 10.
[:SENSe]:RESistance:NPLCycles <n>	Set measurement speed; <n> = 0.01 to 10.
<i>Digits command:</i>	
:DISPlay:DIGits <n>	Set display resolution; <n> = 4, 5, 6, or 7.
<i>Filter commands:</i>	
[:SENSe]:AVERage:TCONtrol <name>	Select filter type; <name> = REPeat or MOVing.
[:SENSe]:AVERage:COUNT <n>	Set filter count; <n> = 1 to 100.
[:SENSe]:AVERage <b>	Enable/disable filter; <b> = ON or OFF.
<i>Rel command</i> <sup>2</sup> :	
:CALCulate2:NULL:STATe <b>	Enable/disable rel; <b> = ON or OFF.

1. The speed setting is global for all functions. Therefore, you can use any of the three commands to set speed.

1. The commands to acquire a rel value are not listed in this table (see Section 8, *Relative* in the 2400 Series SourceMeter User’s Manual).

## Features to enhance DUT testing

### Data store

The data store (buffer) can store from 1 to 2500 readings, and provides statistical data on the stored readings.

### Storing readings

To store readings, press STORE, key in the number of readings to store, and press ENTER. The star (\*) annunciator indicates that the buffer is enabled. To start the storage process, turn the output on and (if necessary) trigger the unit. The star (\*) annunciator turns off after storage is completed.



## Recalling readings

To recall readings, press the RECALL key. The buffer location number is the memory location of the recalled reading. Location #0000 indicates that the displayed reading is stored at the first memory location. To display other stored readings, use the edit keys to change the buffer location number. To exit from the recall mode, press EXIT.

**Timestamp** — Just below the buffer location number is the timestamp (in seconds) for the reading. It can be referenced to the first reading stored in the buffer (absolute timestamp), or it can indicate the time between buffer readings (delta timestamp). If the absolute timestamp is selected, the @ symbol precedes the timestamp value. If the delta timestamp is selected, the  $\delta$  symbol precedes the timestamp value. Regardless of which timestamp is selected, the first reading is always timestamped at zero seconds.

To change the timestamp, exit from the recall mode and use the following menu sequence:

Press CONFIG > press STORE > select ABSOLUTE or DELTA

---

**NOTE** While in the recall mode, buffer statistics (minimum, maximum, peak-to-peak, average and standard deviation) can be displayed using the TOGGLE key. Details about buffer statistics are provided in Section 9 of the 2400 Series SourceMeter User's Manual.

---

## Remote command programming

### SCPI commands

SCPI commands to configure and control the buffer are listed in Table 13.

---

**NOTE** Table 13 does not provide a complete listing of buffer commands. Documentation for all buffer commands (including the ones for buffer statistics) can be found in Section 9 of the 2400 Series SourceMeter User's Manual.

---

Table 1-13

### SCPI commands; data store

Command	Description
:TRACe:POINts <n>	Specify buffer size; <n> = 1 to 2500
:TRACe:FEED <name>	Specify reading source; <name> = SENSE (raw readings), CALCulate (math readings), or CALCulate2 (limits readings).
:TRACe:TSTamp:FORMat <name>	Select timestamp format; <name> = ABSolute or DELTA.
:TRACe:FEED:CONTRol <name>	Enable/disable buffer; <name> = NEXT (fill buffer and stop) or NEVer (disable buffer).
:TRACe:DATA?	Read contents of buffer.
:TRACe:CLEar	Clear buffer.

### Programming example

Table 14 shows a typical command sequence to store and recall readings from the buffer.

Table 1-14

#### Command sequence for data store example

Command*	Comments
*RST	Restore GPIB defaults.
:SOUR:VOLT 10	Set voltage source to 10V.
:TRAC:POINTS 10	Set buffer size to 10.
:TRIG:COUN 10	Trigger count equals number of readings.
:TRAC:FEED SENS	Set to store raw readings.
:TRAC:FEED:CONT NEXT	Enable buffer.
:OUTP ON	Turn on output.
:INIT	Trigger readings.
:TRAC:DATA?	Request raw buffer readings.

\*SourceMeter must be addressed to talk after sending :TRAC:DATA? to acquire data.

## Sweep operation

### Sweep types

The four available sweep types are linear staircase, logarithmic staircase, custom, and source memory.

#### Linear staircase sweep

When the sweep shown in Figure 7 is triggered to start, the output will go from the bias level to the source level. The bias level is the initial source level prior to the start of the sweep. The output will then change in equal steps until the stop source level is reached. With trigger delay set to zero, the time duration at each step is determined by the source delay and the time it takes to perform the measurement.

With the desired source (V or I) selected, use the following menu sequence to set the start, stop and step source levels:

Press CONFIG > press SWEEP > select TYPE > select STAIR

After selecting STAIR, you will be prompted to enter the START, STOP and STEP levels.

Figure 1-7  
**Linear staircase sweep**

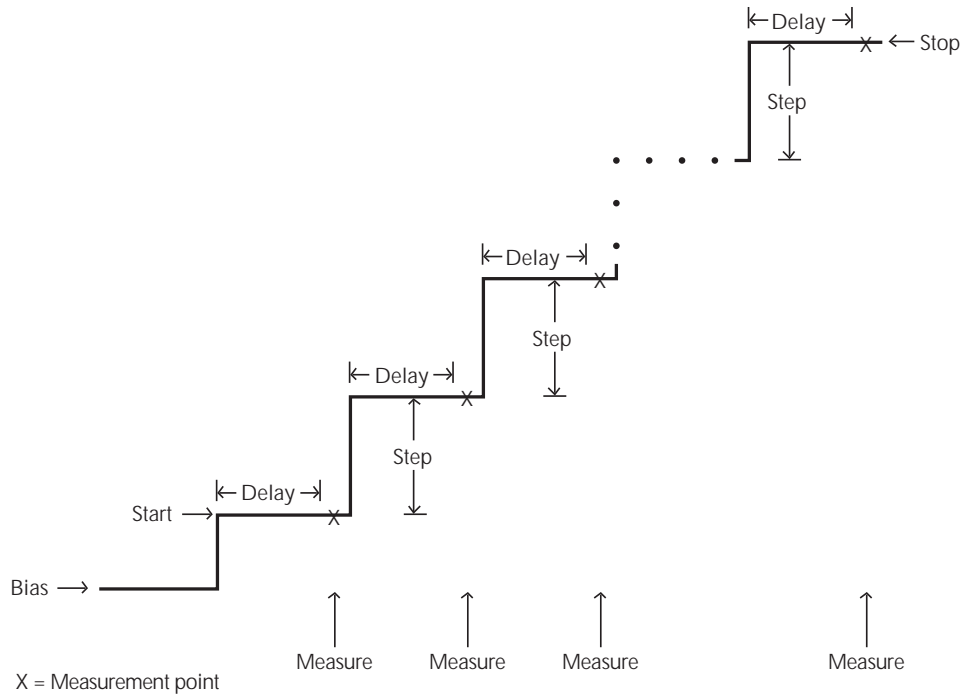

### Logarithmic staircase sweep

This sweep is similar to the linear staircase sweep. The steps, however, are done on a logarithmic scale. The symmetrical log points for the steps are determined by the specified number of sweep points. Figure 8 shows a 5-point log sweep from 1 to 10V.

With the desired source (V or I) selected, use the following menu sequence to set the start and stop levels, and the number of sweep points (2 to 2500):

Press CONFIG > press SWEEP > select TYPE > select LOG

After selecting LOG, you will be prompted to enter the START and STOP levels, and the NO OF POINTS.

Figure 1-8  
**Logarithmic staircase sweep (example)**

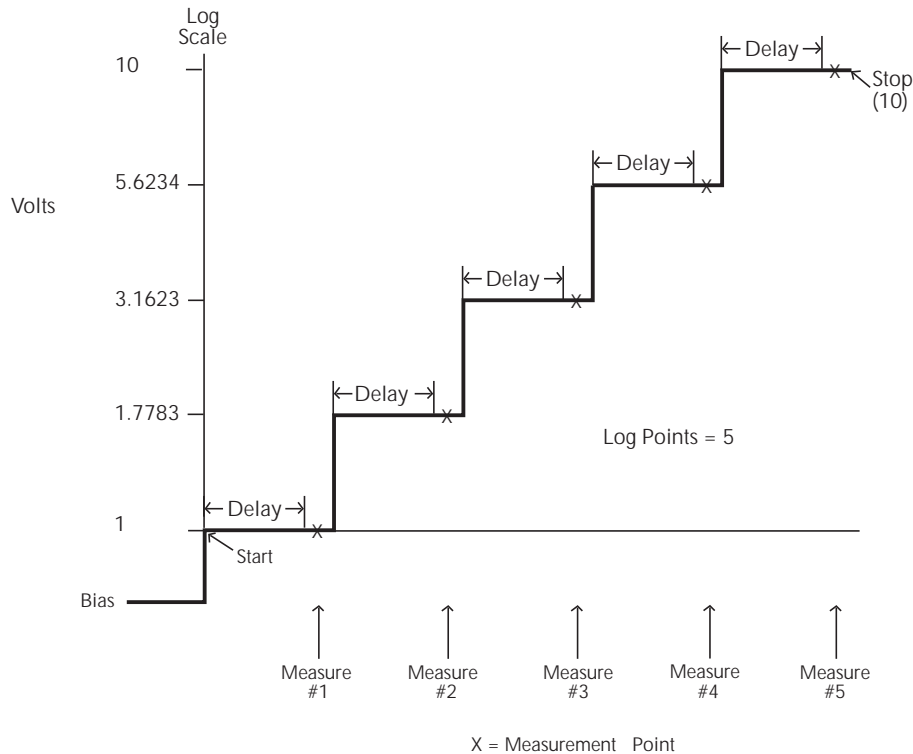

### Custom sweep

For a custom sweep, the user specifies the number of point in a sweep, and the source level at each point. Figure 9 shows a 6-point, 50% duty cycle pulse sweep. The specified voltage level at points P0, P2 and P4 is 1V, while the voltage level at P1, P3 and P5 is 0V.

With the desired source (V or I) selected, use the following menu sequence to specify the number of sweep points and the source level at each point:

Press CONFIG > press SWEEP > select TYPE > select CUSTOM

After selecting CUSTOM, these menu items will be displayed:

# POINTS - Use to specify the number of points in the sweep (1 to 2500)

ADJUST POINTS - Use to set the source level at each point in the sweep. The first point in the sweep is P0000. After setting the level for P0000, increment the pointer to P0001 and set the level for that point. In a similar manner, set the level for each point in the sweep.

INIT - This option allows you to set a consecutive range of sweep points to a specified level. After selecting INIT, you will be prompted to enter the source VALUE, the START PT (point), and the STOP PT (point). For example, if you want points 10 through 15 to be 1V, set VALUE to 1V, START PT to 10, and STOP PT to 15.

Figure 1-9

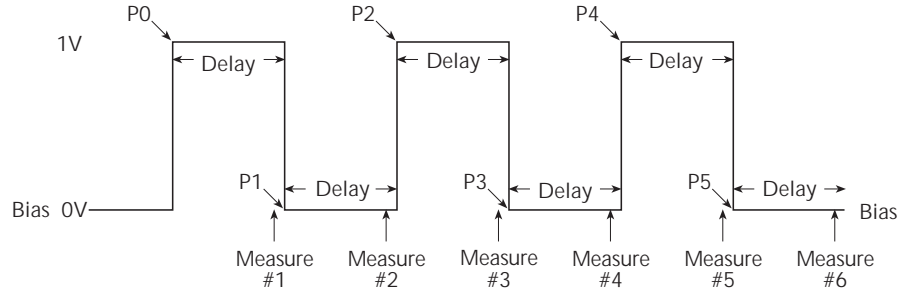
**Custom pulse sweep (example)****Source memory sweep**

For a source memory sweep, up to 100 setup configurations can be saved in memory. When the sweep is run, the setup at each memory point is recalled. This allows multiple functions and math expressions to be used in a sweep.

A SourceMeter setup configuration is saved in memory by performing the following menu sequence:

Press MENU > select SAVESETUP > select SOURCE MEMORY > select SAVE

After selecting SAVE, you will be prompted to enter the memory location where you want to store the setup.

After saving all your test setups in concurrent memory locations, use the following menu sequence to configure the sweep:

Press CONFIG > press SWEEP > select TYPE > select SRC MEMORY

After selecting SRC MEMORY, the following menu items will be displayed:

START - Use this menu item to set the starting memory location for the sweep. For example, if your first setup is stored in memory location 001, set the start point to 001.

# POINTS - Use to specify the number of points (memory locations) in the sweep. For example, if there are 10 points in the sweep, set the number of points to 010.

---

NOTE NPLC caching can be used to speed up source memory sweeps. See “NPLC caching” in Section 3 of the 2400 Series User’s Manual.

---

**Sweep count**

For front panel operation, a sweep can automatically repeat a specified number of times (finite sweep count) or it can repeat continuously (infinite sweep count).

For a finite count sweep, the readings are automatically stored in the buffer. The maximum number of finite sweeps that can be performed is determined as follows:

Maximum finite sweep count = 2500 / # points in sweep.

For an infinite sweep count, the readings are not stored in the buffer.

Use the following menu sequence to set sweep count:

Press CONFIG > press SWEEP > select SWEEP COUNT > select FINITE or INFINITE

If you select FINITE, you will be prompted to enter the sweep count.

## Source ranging

There are three options to control source ranging for a sweep; fixed, best fixed, and auto range. With the fixed option selected, the SourceMeter stays on the source range that is selected at the start of the sweep.

With best fixed selected, the largest source value in the sweep determines the range. For example, if sweeping from 1V to 15V, the best fixed option will select the 20V range.

With the auto range option selected, the SourceMeter will select the most sensitive range for each source value. For example if sweeping from 1V to 15V in 1V steps, the SourceMeter will source 1V and 2V on the 2V range, and source the remaining source values on the 20V range.

Use the following menu sequence to select the source ranging option:

Press CONFIG > press SWEEP > select SOURCE RANGING > select BEST FIXED, AUTO RANGE or FIXED

## Source delay

Source delay allows the source to settle before a measurement is performed. As shown in Figures 6, 7, and 8, the delay occurs on each step (level) of the sweep. The delay can be set automatically by the SourceMeter (auto delay) or it can be set manually.

With auto delay selected, the delay setting will be 1ms, 2ms or 3ms depending on which current range and source function is being used (see Section 3, *Source delay* in the 2400 Series SourceMeter User's Manual). Manually, the source delay can be set from 0000.0000 to 9999.9980 sec.

Use the following menu sequence to set source delay:

Press CONFIG > press SOURCE V (or I) > select DELAY or AUTO DELAY

If DELAY is selected, you will be prompted to enter the delay value (in seconds). If AUTO DELAY is selected, you will be prompted to DISABLE or ENABLE auto delay.

## Performing sweeps

### Performing a linear staircase sweep

Perform the following steps to run a linear staircase sweep:

1. Configure the source and measure functions. The source level you set becomes the bias level for the sweep. Typically, 0V or 0A is used as the bias level.
2. Configure the linear staircase sweep, including start, stop, and step values, as previously explained.
3. Set the source delay as required.
4. Turn the output on. The SourceMeter will output the bias level.
5. Run the sweep by pressing the SWEEP key. When finished, turn the output off.

The readings will be stored in the buffer if a finite count sweep was run.

### Performing a log staircase sweep

Perform the following steps to run a log staircase sweep:

1. Configure the source and measure functions. The source level you set becomes the bias level for the sweep.
2. Configure the log staircase sweep, including start and stop values and number of points, as previously explained.
3. Set the source delay as required.
4. Turn the output on. The SourceMeter will output the bias level.
5. Run the sweep by pressing the SWEEP key. When finished, turn the output off.

The readings will be stored in the buffer if a finite count sweep was run.

### Performing a custom sweep

Perform the following steps to run a custom sweep:

1. Configure the source and measure functions. The source level you set becomes the bias level for the sweep.
2. Configure the custom sweep by choosing the number of points and initial value. Also be sure to adjust individual sweep points as required.
3. Set the source delay.
4. Turn the output on. The SourceMeter will output the bias level.
5. Run the sweep by pressing the SWEEP key. When finished, turn the output off.

The readings will be stored in the buffer if a finite count sweep was run.

### Performing a source memory sweep

Perform the following steps to run a source memory sweep:

1. Configure and save source and measure functions for each sweep point in individual source memory locations, as previously explained.
2. Configure the source memory sweep by choosing the start memory location and number of points.
3. Turn the output on.
4. Run the sweep by pressing the SWEEP key. When finished, turn the output off.

The readings will be stored in the buffer if a finite count sweep was run.

## Remote command programming

### SCPI commands

SCPI commands for linear, logarithmic and custom sweeps are listed in Table 15.

NOTE Table 15 does not provide a complete listing of sweep commands. Documentation for all sweep commands can be found in Section 10 of the 2400 Series Source-Meter User's Manual

Table 1-15  
SCPI commands; sweeping

Command*	Description
:SOURce:xxx:MODE <name>	Select source mode; <name> = FIXed, LIST or SWEep.
:SOURce:DElAY <n>	Set source delay; <n> = 0 to 9999.9980 (sec).
:SOURce:DElAY:AUTO <b>	Enable/disable auto delay; <b> = ON or OFF.
:TRIGger:COUnT <n>	Set trigger count; <n> = Number of points in sweep.
Linear and logarithmic sweeps:	
:SOURce:SWEep:SPACing <name>	Select sweep scale; <name> = LINear or LOGarithmic.
:SOURce:SWEep:RANGing <name>	Select source ranging: <name> = BEST, AUTO, or FIXed.
:SOURce:xxx:STARt <n>	Specify sweep start level; <n> = V or I source value.
:SOURce:xxx:STOP <n>	Specify sweep stop level; <n> = V or I source value.
:SOURce:xxx:STEP <n>	Specify linear sweep step level; <n> = V or I source value.
:SOURce:SWEep:POINts <n>	Set number of sweep points; <n> = 2 to 2500.
Custom (list) sweep:	
:SOURce:LIST:xxx <list>	Define source list; <list> = value1, value2, ... valueN.
:SOURce:LIST:xxx:APPend <list>	Add source list value(s); <list> = value1, value2, ... valueN.
:SOURce:LIST:xxx:POINts?	Query length of source list.
Source memory sweep:	
:SOURce:FUNCTion MEM	Select source memory sweep mode.
:SOURce:MEMory:SAVE <n>	Save setup in memory location; <n> = 1 to 100.
:SOURce:MEMory:RECall <n>	Return to specified setup; <n> = 1 to 100.
:SOURce:MEMory:STARt <n>	Set source memory start location; <n> = 1 to 100.
:SOURce:MEMory:POINts <n>	Specify number of sweep points; <n> = 1 to 100.

\*:xxx = :VOLTage or :CURRent.



## Programming examples

Programming examples for a linear, logarithmic, custom, and source memory sweep are provided in Table 16.

Table 1-16

### Command sequences for sweep examples

Command*	Comments
Linear staircase sweep:	See Figure 6
*RST	Restore GPIB defaults (source V, measure I).
:SOUR:VOLT 0	Set bias level to 0V.
:SOUR:DEL 0.1	Set delay to 100ms.
:SOUR:SWE:RANG BEST	Select best source ranging.
:SOUR:VOLT:MODE SWE	Select the sweep source mode.
:SOUR:SWE:SPAC LIN	Select the linear sweep scale.
:SOUR:VOLT:STAR 1	Set start level to 1V.
:SOUR:VOLT:STOP 10	Set stop level to 10V.
:SOUR:VOLT:STEP 1	Set step level to 1V.
:TRIG:COUN 10	Set trigger count to 10.
:OUTP ON	Turn output on.
:READ?	Trigger sweep and acquire data.
Logarithmic staircase sweep:	See Figure 7
*RST	Restore GPIB defaults (source V, measure I).
:SOUR:VOLT 0	Set bias level to 0V.
:SOUR:DEL 0.1	Set delay to 100ms.
:SOUR:SWE:RANG BEST	Select best source ranging.
:SOUR:VOLT:MODE SWE	Select the sweep source mode.
:SOUR:SWE:SPAC LOG	Select the log sweep scale.
:SOUR:VOLT:STAR 1	Set start level to 1V.
:SOUR:VOLT:STOP 10	Set stop level to 10V.
:SOUR:SWE:POIN 5	Set number of sweep points to 5.
:TRIG:COUN 5	Set trigger count to 5.
:OUTP ON	Turn output on.
:READ?	Trigger sweep and acquire data.
Custom (list) sweep:	See Figure 8
*RST	Restore GPIB defaults (source V, measure I).
:SOUR:VOLT 0	Set bias level to 0V.
:SOUR:DEL 0.1	Set delay to 100ms.
:SOUR:SWE:RANG BEST	Select best source ranging.
:SOUR:VOLT:MODE LIST	Select the list source mode.
:SOUR:LIST:VOLT 1, 0, 1, 0, 1, 0	Specify source list (1V, 0V, 1V, 0V, 1V and 0V).
:TRIG:COUN 6	Set trigger count to 6.
:OUTP ON	Turn output on.
:READ?	Trigger sweep and acquire data.

\*SourceMeter must be addressed to talk after sending :READ? and :CALC:DATA? to acquire data.

Table 1-16 (cont.)  
**Command sequences for sweep examples**

Command*	Comments
Source memory sweep:	Three point sweep; source V, calculate power, source I.
<i>'Memory location 001 setup:</i>	
*RST	Restore GPIB defaults
:SOUR:VOLT:LEV 15	Set voltage source to 15V.
:SOUR:MEM:SAVE 1	Save setup in memory location 001.
<i>'Memory location 002 setup:</i>	
:CALC:MATH:NAME "POWER"	Select POWER math function (see <i>Math functions</i> ).
:CALC:STAT ON	Enable the power calculation.
:SOUR:MEM:SAVE 2	Save setup in memory location 002.
<i>'Memory location 003 setup:</i>	
:CALC:STAT OFF	Disable math function.
:SOUR:FUNC CURR	Select current source function.
:SOUR:CURR:LEV 50e-6	Set current source to 50µA.
:SENS:FUNC "VOLT"	Select voltage measurement function.
:SOUR:MEM:SAVE 3	Save setup in memory location 003.
<i>'Configure source memory sweep:</i>	
:SOUR:FUNC MEM	Select source memory sweep mode.
:SOUR:MEM:POIN 3	Set sweep points to 3.
:SOUR:MEM:STAR 1	Set start point at memory location 001.
:TRIG:COUN 3	Set trigger count to 3 (must be same as sweep points).
<i>'Trigger sweep and acquire data:</i>	
:OUTP ON	Turn output on.
:READ?	Trigger sweep and acquire three source-measure data strings.
:CALC:DATA?	Acquire result of power calculation.
:OUTP OFF	Turn output off.

\*SourceMeter must be addressed to talk after sending :READ? and :CALC:DATA? to acquire data.

## Limit testing

There is one hardware test (Limit 1; compliance) and 10 software tests (Limits 2, 3, 5-12; high/low limits) available for limit testing. (Limit 4 is reserved for the contact check option.) For basic, pass/fail, non-binning limit testing, you should use only one software test at a time.

---

**NOTE** Limit testing using a component handler to perform binning operations is summarized in the “More testing techniques” section of this guide. For complete details on all aspects of limit testing, see the 2400 Series SourceMeter User’s Manual, Section 12.

---

### Limit 1 (compliance)

This hardware (H/W) test uses the programmed compliance as the test limit. At or above the test limit, the source is in compliance. Below the limit, the source is not in compliance.

The test can be set to fail if the source is in compliance or fail if it is out of compliance. If Limit 1 fails, the FAIL message is displayed and the testing process for that DUT is terminated. A pass condition allows the testing process to the next enabled software test.

For example, assume the SourceMeter is set to output 1mA with 1V compliance. If the DUT is above 1k $\Omega$  the source will be in compliance. If the DUT is below 1k $\Omega$  the source will be out of compliance.

Use the following menu sequence to configure Limit 1:

Press CONFIG > press LIMIT > select H/W LIMITS

After selecting H/W LIMITS, these menu items will be displayed:

CONTROL - Use to ENABLE or DISABLE the test.

FAIL MODE - If you want the test to fail if the source is in compliance, select IN. If you want the test to fail if it is not in compliance, select OUT.

### Limit 2, 3, and 5 through 12 tests

These software (S/W) tests are used to determine if a DUT is within specified high and low measurement limits. Typically, Limit 2 is set for the widest limits, while additional limit tests are set for progressively narrower limits.

Use the following menu sequence to configure the software limit tests:

Press CONFIG > press LIMIT > select S/W LIMITS > select the desired limit test

After selecting the desired limit test (i.e., LIM2), these menu options will be displayed:

CONTROL - Use to ENABLE or DISABLE the test.

LOLIM - Use to enter the low limit value. You will then be prompted to enter the bit pattern for binning operations. Since binning operations are being done at this time, simply press ENTER or EXIT.

HILIM - Use to enter the high limit value. You will then be prompted to enter the bit pattern for binning operations. Since binning operations are being done at this time, simply press ENTER or EXIT.

### Limit testing operation

1. Connect the DUT to the SourceMeter.
2. Configure the source-measure functions of the SourceMeter.
3. Select and configure a limit test as previously explained.
4. Turn the output on.
5. Press the LIMIT key to enable the test. The pass/fail status of the test will be displayed.

The test can be disabled by again pressing the LIMIT key.

## Remote command programming

### SCPI commands

SCPI commands for basic non-binning limit testing are listed in Table 17.

---

NOTE Table 17 does not provide a complete listing of limit commands. See Sections 12 and 18 of the 2400 Series SourceMeter User's Manual for complete documentation.

---

Table 1-17

#### SCPI commands; basic non-binning limit testing

Command*	Description*
For all limit tests: :CALCulate2:DATA?	Acquire limit test reading(s).
Limit 1 test: :CALCulate2:LIMit:STATe <b> :CALCulate2:LIMit:COMPLiance:FAIL <.name> :CALCulate2:LIMit:FAIL?	Enable/disable Limit 1 test; <b> = ON or OFF. Set Limit 1 fail condition; <name> = IN (fail if in compliance) or OUT (fail if not in compliance). Query Limit 1 test result (0 = pass, 1 = fail).
Limit 2, 3, 5-12 tests: :CALCulate2:LIMitX:STATe <b> :CALCulate2:FEED <name> :CALCulate2:LIMitX:LOWer <n> :CALCulate2:LIMitX:UPPer <n> :CALCulate2:LIMitX:FAIL?	Enable/disable Limit X test; <b> = ON or OFF. Select input path; <name> = CALCulate[1], VOLTage, CURRent or RESistance. Set lower limit for Limit X; <n> = limit. Set upper limit for Limit X; <n> = limit. Query Limit X test result (0 = pass, 1 = fail).

\*LIMitX = LIMit2, LIMit3, LIMit5 through LIMit12.

### Programming example

The programming example in Table 18 tests 1kΩ resistors. If the tested resistor is within 5% of it's nominal value, it will pass the test. Otherwise the test will fail.

Table 1-18  
**Command sequence for Limit 2 test example**

Command*	Comments
*RST	Restore GPIB defaults.
:SENS:FUNC "RES"	Select ohms measurement function.
:CALC2:LIM2:STAT ON	Enable Limit 2 test.
:CALC2:FEED RES	Use ohms for limits comparison.
:CALC2:LIM2:LOW 950	Set lower limit to 950Ω
:CALC2:LIM2:UPP 1050	Set upper limit to 1050Ω
:OUTP ON	Turn output on.
:INIT	Trigger reading.
:CALC2:LIM2:FAIL?	Query result of Limit 2 test (0 = pass, 1 = fail).
:OUTP OFF	Turn output off.

\*SourceMeter must be addressed to talk after sending :CALC2:LIM2:FAIL? to acquire test result.

## Math functions

The SourceMeter has five built-in math functions; power, offset compensated ohms, varistor alpha, voltage coefficient and percent deviation. After a math function is configured and enabled, it can be selected by pressing the FCTN key (MATH annunciator displayed).

### Power

Calculates and displays power using the measured voltage (V) and measured current (I) values as follows:

$$\text{Power} = V \times I$$

Use the following menu sequence to enable the power math function:

Press CONFIG > press FCTN > select POWER

This math function can now be selected by pressing the FCTN key.

### Offset-compensated $\Omega$

Thermal EMFs can corrupt low-resistance measurements. An offset-compensated  $\Omega$  measurement cancels out unwanted offset by performing the following 2-point measurement process:

$$\text{Offset-Compensated } \Omega = \Delta V / \Delta I$$

$$\text{where: } \Delta V = V_2 - V_1$$

$$\Delta I = I_2 - I_1$$

V1 and I1 are V and I measurements with the source set to a specific level.

V2 and I2 are V and I measurements with the source set to a different level (typically zero).

Select the desired source function (V or I), and use the following menu sequence to configure and enable the offset-compensated  $\Omega$  math function:

Press CONFIG > press FCTN > select OFF COMP OHMS

After selecting OFF COMP OHMS, you will be prompted to enter the two source values.

This math function can now be selected by pressing the FCTN key.

---

**NOTE** Offset-compensated  $\Omega$  is also available from the CONFIG OHMS menu. Using Offset-compensated  $\Omega$  from this menu automatically selects zero as one of the source values. For details, see “Measure ohms” in the “Basic SourceMeter operations” section of this guide.

---

### Voltage coefficient

High value resistors exhibit a change in resistance with a change in applied voltage. The voltage coefficient is the percent change in resistance per unit change in applied voltage:

$$\text{Coefficient \%} = \frac{\Delta R}{R2 \times \Delta V}$$

where:  $\Delta R = R2 - R1$

$$\Delta V = V2 - V1$$

R1 and R2 are the resistance measurements at the two source points.

V1 and V2 are the voltage measurements at the two source points.

After selecting the desired source function (V or I), use the following menu sequence to configure and enable the voltage coefficient math function:

Press CONFIG > press FCTN > select VOLT COEFF

After selecting VOLT COEFF, you will be prompted to enter the two source values.

This math function can now be selected by pressing the FCTN key.

### Varistor alpha

Determines ALPHA ( $\alpha$ ), which is the logarithmic ratio of two voltage measurement points on a non-linear V-I curve.

$$\alpha = \frac{\log(I2 / I1)}{\log(V2 / V1)}$$

where: V1 is the voltage measurement at the first I-Source point (I1).

V2 is the voltage measurement at the second I-Source point (I2).

The log (x) function uses the absolute value of x.

Use the following menu sequence to configure and enable the varistor alpha math function:

Press CONFIG > press FCTN > select VAR ALPHA

After selecting VAR ALPHA, you will be prompted to enter the two I-Source values.

This math function can now be selected by pressing the FCTN key.

## Percent deviation

This calculation provides the percent deviation between the normal display reading and the user specified reference value:

$$\% \text{ Deviation} = \frac{(X - Y)}{Y} \times 100$$

where: X is the normal display measurement reading.

Y is the reference value.

The reference value (Y) can be a user-specified value or a reading acquired by the SourceMeter.

Use the following menu sequence to configure and enable the percent deviation math function:

Press CONFIG > press FCTN > select %DEV

After selecting %DEV you will be prompted to set the reference value. Either key in the reference value, or (with the output on) press the AUTO key to trigger a measurement. The measured reading will be displayed as the reference.

**Limit testing** – After the reference value is entered, you will be prompted to enter high and low tolerances (in %) for the reference value. These tolerances set the high and low limits for Limit 2 test. For example, if the reference value is 1kΩ and the high and low tolerances are 5%, the high limit for Limit 2 test will be 1050Ω and the low limit will be 950Ω

This math function can now be selected by pressing the FCTN key. The percent deviation and the result of the limit test (PASS or FAIL) will be displayed.

## Remote command programming

### SCPI commands

SCPI commands for the built-in math functions are listed in Table 19.

---

NOTE The percent deviation math function is not provided as a built-in math function for remote operation. However, it can be configured as a user-defined expression (see CALCulate[1] commands in Section 18 of the 2400 Series SourceMeter User's Manual).

---

Table 1-19

### SCPI commands; built-in math functions

Command	Description
:CALCulate:MATH:NAME <name>	Select math expression; <name> = "POWER", "OFFCOMPOHM", "VOLTCOEF" or "VARALPHA".
:CALCulate:STATE <b>	Enable/disable math; <b> = ON or OFF.
:CALCulate:DATA?	Query math data.

### Programming example

The programming example in Table 20 configures the SourceMeter to operate as a power meter (power = V x I). Programming examples for other math functions are provided in the 2400 Series SourceMeter User's Manual (see CALCulate1 subsystem in Section 18).

Table 1-20

**Command sequence for power measurement example**

Command*	Comments
*RST	Restore GPIB defaults (source 0V, measure I).
:SOUR:VOLT:RANG 0.2	Select the 200mV source range.
:SENS:FUNC "VOLT", "CURR"	Select V and I measurement functions.
:SENS:CURR:PROT 100e-3	Set current compliance to 100mA.
:SENS:VOLT:RANG:AUTO ON	Select auto range for voltage measurements.
:SENS:CURR:RANG:AUTO ON	Select auto range for current measurements.
:CALC:MATH:NAME "POWER"	Select the power math expression.
:CALC:STAT ON	Enable math.
:OUTP ON	Turn output on.
:INIT	Trigger source-measure action.
:CALC:DATA?	Request power reading.
:OUTP OFF	Turn output off.

\*SourceMeter must be addressed to talk after sending :CALC:DATA? to acquire power reading.

**Pulse mode (Model 2430 only)**

While in the Pulse Mode, the Model 2430 can output one or more pulses. It can output current pulses up to 10.5A at 105V, or voltage pulses up to 105V at 10.5A. For details on Pulse Mode operation, see the 2400 Series SourceMeter User's Manual, Section 5.

**Pulse characteristics**

Figure 10 shows a typical pulse period. It consists of an output on-time (pulse width) and an output off-time.

---

**NOTE** For the following discussion on pulse characteristics, it is important to understand that a typical measured reading consists of three measurement conversions. The signal (pulse) is measured, a precise internal reference is measured and finally, zero (common) is measured. The reading is calculated from these measurements.

---

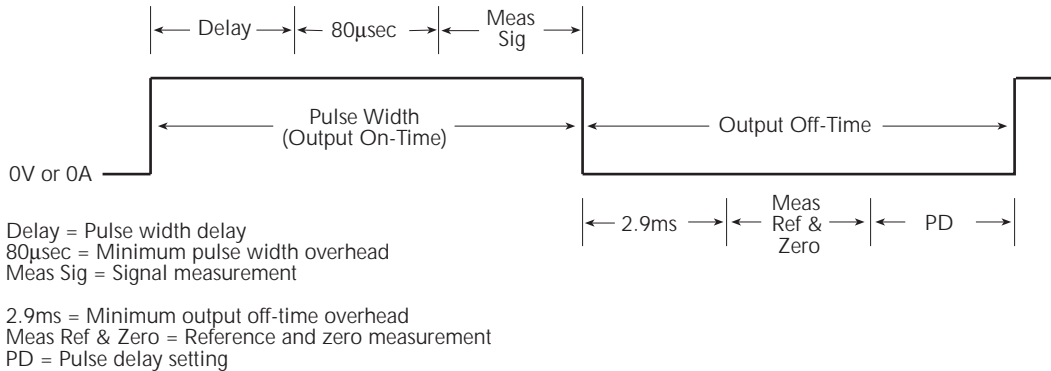

Figure 1-10

**Pulse-measure timing**

**Pulse width** — The setting range for pulse width is from 150µsec to 5msec. Note however, that the minimum pulse width that can be achieved in Figure 10 is determined by the minimum pulse width overhead (80µsec), and the time it takes to measure the signal. For example if the measure speed is set to 0.1 PLC, it will take 1.667msec to measure the signal (0.1/60Hz). Therefore, the minimum pulse width would be 1.747msec. Setting pulse width to a value less than that is ignored.

If (for the same example) the pulse width setting exceeds 1.747msec, the difference becomes the “Delay” portion of the output on-time. If you set pulse width to 3msec, then the “Delay” becomes 1.253msec.

For remote operation, all measurements can be disabled. This reduces on-time overhead to 150µsec (minimum).

**Output off-time** — As shown in Figure 10, the output off-time consists of a minimum overhead (2.9msec), the time it takes to measure the reference and zero, and the user-set pulse delay (PD). For example, if the measure speed is set to 0.1 PLC, it will take 3.334msec to measure the reference and zero (2 x 1.667msec). With pulse delay set to zero, the minimum pulse off-time would be 6.234msec.

The output off-time can be reduced by disabling auto-zero. With auto zero disabled, the reference and zero are not measured, and the overhead time is reduced to 1.4msec (minimum). With auto zero disabled, zero drift will eventually corrupt accuracy.

For remote operation, all measurements can be disabled. This reduces off-time overhead to 1.1msec (minimum).

**Pulse duty cycle**

Duty cycle, the percentage of time during the pulse period that the output is on, is calculated as follows:

$$\text{Duty cycle} = \text{Pulse width} / (\text{Pulse width} + \text{Off-time})$$

For example, if the pulse width is 1msec and the off-time is 9msec, duty cycle is calculated as follows:

$$\begin{aligned} \text{Duty Cycle} &= 1\text{msec} / (1\text{msec} + 9\text{msec}) \\ &= 1\text{msec} / 10\text{msec} \\ &= 0.10 \text{ (10\%)} \end{aligned}$$

## 10A range limitations

### Pulse width

The maximum pulse width for the 10A range (source or measure) is 2.5msec. If the setting is >2.5msec, the SourceMeter will limit the pulse width to 2.5msec.

### Charge energy consumption

Energy for pulses are provided by an internal bank of capacitors. Each pulse consumes energy from the capacitors. The following pulse will not occur until the capacitors have had enough time to sufficiently recharge.

Charge energy consumption by a pulse depends on the pulse current and pulse width. A long high current pulse consumes more energy than a short low current pulse. On all but the 10A range (source or measure), charge energy consumption is low enough to allow the capacitors sufficient time to recharge between pulses. The result is consistent pulse output.

On the 10A range (source or measure), the configured pulse period will be consistent as long as the pulse duty cycle is 8% or less. Above 8%, the capacitors will not be able to recharge sufficiently before the next pulse is due. As a result, the pulse period becomes longer and inconsistent.

If a consistent pulse period is not required for your test, you can use the 10A range to output fast, high energy (>8% duty cycle) pulses. With pulse delay set to 0sec, each subsequent pulse will output as soon as the capacitors become sufficiently charged.

## Pulse Mode configuration

### Select Pulse Mode, set pulse width and pulse delay

Use the following menu sequence to select the Pulse Mode:

Press CONFIG > press SOURCE V (or I) > select SHAPE > select PULSE

After PULSE is selected, use the following menu items to program pulse parameters:

DELAY - Use to set the pulse delay for the output off-time (0 to 9999.99900 sec).

PULSE WIDTH - Use to set the pulse width (0.15ms to 5.00ms). Note that pulse width will internally limit to 2.5ms on the 10A range (source or measure).

### Set pulse measurement speed

With the Pulse Mode selected, pulse measurement speed can be set from 0.004 to 0.1 PLC. To set speed, press SPEED and enter the desired NPLC value.

### Set pulse count

Arm count and trigger count determines how many pulses will be output. In general, pulse count is the product of arm count and trigger count. If arm count is set to infinite, pulses will output continuously. Note that the product of the finite count values cannot exceed 2500.

**Arm count** - Use the following menu sequence to set the arm count:

Press CONFIG > press TRIG > select ARM LAYER > select COUNT

After selecting COUNT, the following menu items are displayed:

FINITE - Use to set arm count to a finite value.

INFINITE - Use to set arm count to infinity.

**Trigger count** - Use the following menu sequence to set the trigger count:

Press CONFIG > press TRIG > select TRIG LAYER > select COUNT > set TRIG COUNT

### Enable/disable auto zero

Use the following menu sequence to enable or disable auto zero:

Press MENU > select A/D CTRL > select AUTO ZERO > select DISABLE or ENABLE

### Pulse Mode operation

---

---

**WARNING** *Hazardous voltage ( $\geq 30V$  rms) can appear on input/output LO when performing fast pulse operations. To eliminate this shock hazard connect the LO terminal to chassis ground or to a known safety earth ground. If using the front panel terminals, ground front panel LO. If using the rear panel terminals, ground the rear panel LO.*

---

---

The following steps summarize the basic procedure to output pulses:

1. As previously explained, configure the SourceMeter for Pulse Mode operation (see *Pulse Mode configuration*).
2. Select the source (SOURCE V or SOURCE I), and set the pulse level and compliance limit.
3. Select the measurement function and, if not measuring the source, select the measurement range. Note that AUTO range is not valid in the Pulse Mode.
4. Turn the output on. During the output on-time, the red OUTPUT indicator light will be on, and during the off-time, the indicator will be off.
5. If the pulse count is a finite value, the output will turn off after the last pulse is sourced. The output can be turned off at any time by pressing ON/OFF key.

### Pulse ohms measurements

While in the Pulse Mode, auto or manual ohms measurements can be performed. Also, offset-compensated ohms is available as a math function. After selecting and configuring the Pulse Mode, perform the desired ohms measurement procedure as explained earlier in this guide (see *Measure ohms* in *Basic SourceMeter operations*).

### Pulse Mode sweeps

When performing a Pulse Mode sweep, the output will alternate between each sweep point and zero. After selecting and configuring the Pulse Mode, configure and run the desired sweep as explained earlier in this guide (see *Sweep operation*).

### Pulse-measure considerations

In order to provide fast pulse periods, there are some aspects of normal DC Mode operation that are different for the Pulse Mode. All the pulse-measure considerations are covered in Section 5 of the 2400 Series SourceMeter User's Manual. Some of the more discernible differences are summarized as follows:

**Measurement speed** — In the normal DC Mode of operation, speed can be set from 0.01 to 10 PLC. In the Pulse Mode, speed can be set from 0.004 to 0.1 PLC.

**Filter** — Filtering is not used while in the Pulse Mode.

**Auto range** — Auto range is invalid while in the Pulse Mode.

**Source delay** — In the DC Mode, source delay is the delay between the source and measure actions. When the Pulse Mode is selected, source delay is replaced by pulse delay. Pulse delay is the user set delay that occurs during the off-time portion of the pulse period.

**Trigger delay** — In the DC Mode, trigger delay is a user set delay that occurs between the trigger and source actions. In the Pulse Mode, trigger delay is not used.

## Remote command programming

### SCPI commands

SCPI commands that are used to select and configure the Pulse Mode are listed in Table 21

Table 1-21

#### SCPI commands; select and configure Pulse Mode

Command *	Description
:SOURce:FUNCtion:SHAPE PULSe	Select Pulse Mode operation.
:SOURce:PULSe:WIDTh <n>	Set pulse width (in sec); <n> = 0.00015 to 0.005.
:SOURce:PULSe:DELay <n>	Set pulse delay (in sec); <n> = 0 to 9999.999.
:SENSe:xxx:NPLC <n>	Set pulse measurement speed; <n> = 0.004 to 0.1
:ARM:COUNT <n>	Set arm count; <n> = 1 to 2500 or INFinite.
:TRIGger:COUNT <n>	Set trigger count; <n> = 1 to 2500.

\*:xxx = :VOLTage, :CURRent or :RESistance

### Programming example

The command sequence in Table 22 will output 5V pulses that have a 1msec pulse width.

Table 1-22

#### Command sequence for Pulse Mode example

Command*	Comments
*RST	Restore GPIB defaults (source V, measure I).
:SOUR:FUNC:SHAP PULS	Select Pulse Mode.
:SOUR:PULS:WIDT 0.001	Set pulse width to 1msec.
:SOUR:PULS:DEL 1	Set pulse delay to 1 sec.
:SOUR:VOLT:LEV 5	Set source level to 5V.
:SENS:CURR:NPLC 0.01	Set pulse measure speed to 0.01 PLC.
:TRIG:COUN 20	Set pulse count to 20.
:READ?	Trigger and acquire pulse reading strings.

\*SourceMeter must be addressed to talk after sending :READ? to acquire pulse readings.



北京海洋兴业科技股份有限公司 (证券代码: 839145)

北京市西三旗东黄平路19号龙旗广场4号楼 (E座) 906室

电话: 010-62176775 62178811 62176785

企业QQ: 800057747 维修QQ: 508005118

企业官网: [www.hyxyyq.com](http://www.hyxyyq.com)

邮编: 100096

传真: 010-62176619

邮箱: [market@oitek.com.cn](mailto:market@oitek.com.cn)

购线网: [www.gooxian.com](http://www.gooxian.com)



扫描二维码关注我们  
查找微信公众号: 海洋仪器