

R&S®HMC8015

Power Analyzer

User Manual



5800532402

 **海洋儀器**
致力于电子测试、维护领域!



DECLARATION OF CONFORMITY

Manufacturer:

ROHDE & SCHWARZ GmbH & Co. KG · Muhl Dorfstr. 15 · D-81671 Munich

The ROHDE & SCHWARZ GmbH & Co. KG herewith declares conformity of the product:

Product name: Power Analyzer
Type: R&S®HMC8015
with Options: HOC740

complies with the provisions of the Directive of the Council of the European Union on the approximation of the laws of the Member States

- relating to electrical equipment for use within defined voltage limits (2006/95/EC) [LVD]
- relating to electromagnetic compatibility (2004/108/EC) [EMCD]
- relating to restriction of the use of hazardous substances in electrical and electronic equipment (2011/65/EC) [RoHS].

Conformity with LVD and EMCD is proven by compliance with the following standards:

EN 61010-1:2010
EN 61010-2-030:2010
EN 61326-1:2013
EN 61326-2-1:2013
EN 55011:2009 + A1:2010, Group 1, Class A
EN 61000-3-2:2014
EN 61000-3-3:2013

For the assessment of electromagnetic compatibility, the limits of radio interference for Class A equipment as well as the immunity to interference for operation in industry have been used as a basis.

Date: 13.08.2015

Signature:



General Information Regarding the CE Marking

All ROHDE & SCHWARZ measuring instruments comply with the regulations of the EMC directive. The ROHDE & SCHWARZ conformity evaluation is based on applicable professional and product standards. In cases where multiple limit values can be used, ROHDE & SCHWARZ will apply the stricter standard of the two. With regard to interference emission, the limit values for businesses and commercial operations including the small business sector are applied (Class 1B). For the susceptibility to interference emissions, the applicable limit values for the industrial sector are used. The signal and data cables that must be connected to the device during operation will necessarily affect the compliance with the acceptance limits to some extent. However, the cables used for this purpose will vary, depending on the application. For operation of the device, the following information and conditions should therefore be observed with regard to interference emission and susceptibility:

1. Data Cables

All connections between measuring instruments or their interfaces and external devices (printers, computers, etc.) must always be implemented with adequately shielded cables. Unless the user manual specifies a shorter maximum cable length, the data cable (input/output, signal/control) may not exceed a total length of 3 m, and may not be located outdoors. If the device interface allows the connection of more than one cable, only one may be connected at a time. Data cables in general should always be double-shielded cable. For the IEEE bus cable, the double-shielded cable HZ72 is recommended and can be ordered from ROHDE & SCHWARZ.

2. Signal Cables

Signal cables used for signal transmission between the measurement point and the measuring device should generally be kept as short as possible. Unless a shorter maximum cable length is specified, the signal cables (input/output, signal/control) may not exceed a total length of 1 m, and may not be located outdoors. All signal cables must be shielded (RG58/U coaxial cable). Care must be taken to achieve a proper ground connection. For signal generators, double-shielded coaxial cables (RG223/U, RG214/U) must always be used.

3. Impact on the Equipment

In the presence of strong high-frequency electric or magnetic fields, unwanted signal components may enter the equipment, despite careful setup of the connected cables and lines. With ROHDE & SCHWARZ measuring instruments, this will neither be destructive nor lead to the shutdown of the equipment. As a result of such external conditions, the displayed values and readings may show minor deviations with respect to the applicable instrument specifications in individual cases.

Content

General Information Regarding the CE Marking.	2
1 Important Information	4
1.1 Symbols	4
1.2 Unpacking	4
1.3 Instrument Setup	4
1.4 Safety	4
1.5 Intended Use	4
1.6 Ambient Conditions	5
1.7 Warranty and Repair	5
1.8 Maintenance	5
1.9 CAT II	6
1.10 Supply Voltage	6
1.11 Limit Values	6
1.12 Batteries and Accumulators/Cells	6
1.13 Product Disposal	7
2 Instrument Controls and Indicators	8
3 Options/Upgrade Vouchers	9
4 Connecting a Device under Test	10
4.1 Connecting a Device under Test via Adapter	10
4.2 Connecting a Device under Test Directly	11
4.2.1 Internal Jack Wiring	11
4.2.2 Voltage-Based Measurement	11
4.2.3 Current-Based Measurement	11
4.2.4 Measurements with an External Shunt or Clamp-on Current Probe	12
4.3 Sensor Menu	12
5 Setting Parameters	13
5.1 Using the Instrument for the First Time	13
5.2 Screen Display Description	13
5.3 Multifunction Softkeys	14
5.4 Configuring the Operating Mode from a List of Measuring Parameter Options ("Cells")	14
5.5 Readout Display	14
5.6 Selecting the Measuring Range	15
6 Instrument Functions	16
6.1 Measurement Parameters	16
6.2 Display Modes (VIEW Menu)	16
6.2.1 Harmonics Mode	17
6.2.2 Waveform Mode	17
6.2.3 Trendchart Mode	18
6.2.4 Inrush Mode	18
6.2.5 Power Software Module (HMExplorer)	19
6.3 Compliance Test	20
6.3.1 EN 50564 / IEC 62301	20
6.3.2 IEC 61000-3-2	21
6.3.3 Test Report	23
6.4 Crest Factor	23
6.5 Energy Counter (Integrator Values)	23
6.5.1 Manual Integrator Mode (Default)	24
6.5.2 Span Integrator Mode	24
6.5.3 Duration Integrator Mode	24
6.5.4 External Integrator Mode	24
6.6 Invert Function	24
6.7 Acquisition Mode	25
6.7.1 Frequency Filter	25
6.7.2 Frequency Source	25
6.8 Peak Hold	25
6.9 Refresh Function	25
6.10 Limits	26
6.11 Analog / Digital Inputs and Outputs	26
6.11.1 Analog IN	26
6.11.2 Analog OUT	26
6.11.3 Digital IN	27
6.11.4 Digital OUT	27
7 Data Logging	28
7.1 Example of Data Format in a Log File	29
7.2 Data Formatting in Excel/Import Wizard	29
8 Documenting, Saving and Retrieving	30
8.1 Device Settings	30
8.2 Screenshots	30
9 General Settings	31
9.1 Updates (Instrument Firmware)	31
9.2 Interface Setup	32
9.3 General Settings (Misc)	32
9.3.1 Device Info	32
9.3.2 Date & Time	32
9.3.3 Sound	32
9.3.4 Display	32
9.3.5 Key Brightness (KEY)	32
9.3.6 Device Name	32
9.3.7 CSV	32
10 Remote Operation	33
10.1 USB VCP	33
10.2 USB TMC	34
10.2.1 USB TMC Configuration	34
10.3 Ethernet	36
10.3.1 Internet Protocol (IP) Networks	36
10.3.2 Ethernet Settings	37
10.3.3 LXI	37
10.3.4 Web Server	37
10.4 IEEE 488.2 / GPIB	38
11 Technical Data	39
12 Appendix	40
12.1 List of Figures	40
12.1 List of Tables	40
12.3 Glossary	41

1 Important Information

1.1 Symbols

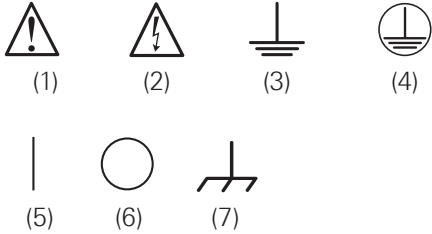

- Symbol 1: CAUTION: General hazard – Observe product documentation
- Symbol 2: Danger of electric shock
- Symbol 3: Earth (ground)
- Symbol 4: Protective conductor terminal
- Symbol 5: ON (supply voltage)
- Symbol 6: OFF (supply voltage)
- Symbol 7: Ground terminal

1.2 Unpacking

When unpacking, check the package contents for completeness (measuring instrument, power cord, product CD, any optional accessories). After you have finished unpacking, check the equipment for any visible shipping-related damage or other mechanical problems. For any damage occurred during transport and shipping, contact the carrier and supplier immediately. Do not use the equipment if it is damaged.

1.3 Instrument Setup

As shown in the picture below, the instrument may be set up at a slight angle by using small extension legs that unfold from its feet. Ensure that the extension legs are completely unfolded to ensure secure footing.



Fig. 1.1: Operating positions.

Position the instrument so the power switch is not obstructed at any time.

1.4 Safety

This instrument is designed in accordance with EN 61010-1 (VDE 0411 Part 1), Safety Requirements for Electrical Equipment for Measurement, Control and Laboratory Use, and left the factory in perfect condition. It thus also meets the requirements of European Standard EN 61010-1 and the international standard IEC 61010-1. To maintain this condition and ensure safe operation, the user

must follow the instructions and warnings contained in this manual carefully. The enclosure, chassis and all measuring terminals are connected to protective ground lead. The device complies with protection class II.



Disabling or separating the intended safety ground connection, either inside or outside the device, is not permitted!

All exposed metal parts have been tested against the AC power leads with a test voltage of 2200 VDC. The instrument complies with overvoltage category CAT II (600 V). To ensure safe operation, the instrument may only be operated from a properly grounded power outlet. Plug in the power cord before connecting any signal circuits. Never use the product if the power cable is damaged. Check the power cable on a regular basis to ensure that it is in proper operating condition. Take appropriate safety measures and carefully lay the power cable to ensure that the cable will not be damaged and that no one can be hurt by, for example, tripping over the cable or suffering an electric shock. Any time there is reason to believe that safe operation is no longer possible, the instrument must be taken out of service and secured against inadvertent use.

Safe operation is not possible:

- If the instrument shows visible damage
- If the instrument is no longer working
- Following long-term storage under unfavorable conditions (e.g. outdoors or in damp rooms)
- After severe transport stress (e.g. in packaging that does not meet the minimum conditions for shipping by post, rail or truck)

Prior to switching on the product, always ensure that the nominal voltage set on the product matches the nominal voltage of the mains supply. If a different voltage is to be set, the mains fuse of the product may have to be changed accordingly.

1.5 Intended Use

This instrument is only intended to be used by persons who are familiar with the risks associated with measuring electrical quantities. The instrument may only be operated with a properly grounded power outlet. Never use a “cheater plug” or other means to defeat or disconnect the protective ground lead. The power plug must be connected before any signal circuits are connected. The product may be operated only under the operating conditions and in the positions specified by the manufacturer, without the product’s ventilation being obstructed. If the manufacturer’s specifications are not observed, this can result in electric shock, fire and/or serious personal injury or death. Applicable local or national safety regulations and rules for the prevention of accidents must be observed in all work performed.

The instrument is intended for use in the following areas:

- Industrial
- Residential
- Business and commercial
- Small business

The measuring device is to be used only with authentic ROHDE & SCHWARZ test accessories, signal cables and power cords. Never use power cords with insufficient ratings. Before starting each measurement, the signal cables should be checked for damage and replaced if necessary. Damaged or worn components may damage the equipment or cause injury.

The instrument may only be used indoors. Before each measurement, check the instrument for proper operation using a known signal source or sample.

To disconnect from the power supply, the rear uncooled IEC plug must be removed.

1.6 Ambient Conditions

The permissible operating temperature is +5°C to +40°C (connector contamination level 2). The maximum permissible relative humidity (non-condensing) is 80 %. During storage or transport, the permissible temperature range is -25 °C to +60 °C. If condensation has formed during transport or storage, the equipment should be allowed to acclimatize to ambient levels for about two hours before use. The instrument is intended for use in clean, dry areas. It may not be operated in dusty or damp conditions, an explosion hazard area, or in the vicinity of aggressive chemicals. The instrument can be positioned as needed, but sufficient air circulation must always be ensured. For prolonged operation, a horizontal or slightly angled operating position (extension legs) is preferable.

 **When installing one or more R&S®HMC8015 units in a 19-inch rack, make sure that there is enough space around its periphery to ensure sufficient cooling (see figure). Recommended minimum clearance: 1 height unit (HU)**



The instrument may be operated at an altitude of up to 2000 m. The specifications and tolerances apply after a warm-up time of at least 60 minutes, at an ambient temperature of 23 °C (± 2 °C). All values stated without tolerances are typical values for an average unit.



The ventilation openings must not be covered!

1.7 Warranty and Repair

ROHDE & SCHWARZ equipment is subject to strict quality control. Before leaving the production line, each device is subjected to a 10-hour “burn-in test”. This is followed by an extensive functional test and quality inspection, in which all operating modes and compliance with specifications are checked. These tests are carried out using equipment that is calibrated traceable to national standards. The statutory warranty provisions of the country in which the ROHDE & SCHWARZ product was purchased are applicable. In the event of any complaints, please contact the dealer from whom you purchased the ROHDE & SCHWARZ product.

All adjustments, parts replacements, maintenance and repairs must be carried out by authorized ROHDE & SCHWARZ specialists. Only original parts may be used for replacing safety-relevant parts (e.g. mains switches, mains transformers, fuses). After each replacement of safety-relevant parts, a safety check (visual inspection, PG conductor test, insulation resistance test, leakage current measurement, functional testing) must be performed. This helps ensure the continued safety of the product.



The product may only be opened by authorized, specially trained personnel. Before any work is performed on the product or before the product is opened, it must be disconnected from the supply voltage. Otherwise, personnel will be exposed to the risk of an electric shock.

1.8 Maintenance

The outside of the instrument should be cleaned regularly with a soft, lint-free dust cloth.

The display may only be cleaned with water or a suitable glass cleaner (not with alcohol or solvents), followed by wiping with a clean, dry, lint-free cloth. Never allow cleaning liquid to enter into the equipment. Other cleaning products may dissolve the labels or mar the plastic surface and painted or varnished surfaces.

Before cleaning the instrument, make sure that it is turned off and disconnected from any power supply (e.g. AC power grid or battery).

No part of the equipment should be cleaned with chemical solvents such as alcohol, acetone or paint thinners!

Important Information

1.9 CAT II

This instrument is intended for measurements on circuits that are or are not connected directly to the normal (low-voltage) AC power grid. The device complies with measurement category CAT II; the input voltage must not exceed $600 V_{RMS}$ in a CAT II application.

The following information relates exclusively to user safety. Other aspects, e.g. the maximum permissible input voltage, are specified in the technical data sheets and must also be observed. Indirect measurements on the power grid may be performed by means of appropriate transducers (e.g. current probes) that meet or exceed the requirements of the protection class applicable to the measurement task. When measuring, the transducer's measurement category – as specified by the manufacturer – must be observed.

Measurement categories

The measurement categories relate to transients superimposed on the AC line voltage. Transients are short, very fast (steep) voltage and current changes that may occur either periodically or non-periodically. The amplitude of possible transients increases as the distance to the source of the low-voltage network decreases.

- **Measurement category IV:** Measurements at the source of the low-voltage network (e.g. on electricity meters).
- **Measurement category III:** Measurements in a building network (e.g. distribution panels, circuit breakers, permanently installed electrical outlets, stationary motors, etc.).
- **Measurement category II:** Measurements on circuits directly connected to the low-voltage power grid (e.g. household appliances, power tools, etc.)
- **0** (Devices with no measurement category rating): Other circuits that are not directly connected to the power grid.

1.10 Supply Voltage

Before turning on this device, please check that the available supply voltage ($115V$ or $230V \pm 10\%$, 50 Hz to 60 Hz) matches the specifications on the supply voltage selector switch of the device. If this is not the case, the supply voltage must be adjusted using the switch. The mains voltage selector switch is located on the rear panel of the unit.

The unit has a main power fuse, which is located on the rear panel of the unit for uncooled IEC connectors. Depending on the supply voltage setting, a fuse of the correct type must be installed.

- At the $115V$ setting: F630L250V
- At the $230V$ setting: F400L250V

If the equipment must be left unattended for a long period of time, it must be switched off at the power switch for safety reasons.



Fig. 1.2: Rear panel with supply voltage selector and connections.

The measuring circuit is equipped with a current overflow fuse against excess current that cannot be serviced or replaced by the user.

1.11 Limit Values

The R&S HMC8015 is equipped with an overload protection circuit. The overload protection circuit is used to prevent damage to the unit, and to protect against possible electrical shock. The limit values of the unit must not be exceeded. The front panel of the R&S HMC8015 specifies the protection limit values in order to ensure safe operation of the unit. These protection limits must be strictly observed:



Fig. 1.3: Connections on the front panel.

Voltage input: $600 V_{RMS}$

Current input: $20A$

Max. voltage between COM and IN: $5 V_{Peak}$

Connection to power supply:
 $115V / 230V$, selectable with the voltage selector on the rear panel of the unit

Frequency: $50-60\text{ Hz}$

Power consumption: $35W$ maximum, $15W$ typical

1.12 Batteries and Accumulators/Cells

If the information regarding batteries and accumulators/cells is ignored or not sufficiently observed, this may lead to explosion, fire and serious personal injury or death. The handling of batteries and accumulators based on alkaline electrolytes must conform to EN 62133.

1. Cells must not be taken apart, opened or crushed.
2. Cells or batteries must not be exposed to heat or fire. Storage in direct sunlight must be avoided. Keep cells and batteries clean and dry. Clean soiled connectors using a dry, clean cloth.

3. Cells or batteries must not be short-circuited. Cells or batteries must not be stored loose in a box or drawer where they can short-circuit each other, or where they can be short-circuited by other conductive materials. Cells and batteries must not be removed from their original packaging until they are ready to be used.
4. Keep cells and batteries out of the reach of children. If a cell or battery has been swallowed, seek immediate medical care.
5. Cells and batteries must not be subjected to any mechanical impacts that are stronger than permitted.
6. If a cell develops a leak, the fluid must not come into contact with the skin or eyes. If contact occurs, wash the affected area with plenty of water and seek medical aid.
7. Cells or batteries that are not properly replaced or charged pose a risk of explosion. To ensure that the product remains safe to use, always replace cells or batteries with the matching type.
8. Cells and batteries must be recycled and kept separate from regular household waste. Accumulators or batteries that contain either lead, mercury or cadmium are hazardous waste. Observe the national regulations regarding waste disposal and recycling.

1.13 Product Disposal



Fig. 1.4: Product labeling in accordance with EN 50419.

The German Electrical and Electronic Equipment Act (ElektroG) implements the following EC directives:

- 2002/96/EC (WEEE) for electrical and electronic equipment waste and
- 2002/95/EC on the Restriction of Use of Hazardous Substances in electrical and electronic equipment (RoHS directive)

At the end of the lifecycle of this product, it may not be disposed of with normal household waste. Moreover, disposal via the municipal collection points for electrical equipment waste is also not permissible. Rohde & Schwarz GmbH & Co. KG fully assumes the manufacturer's obligations to take back and dispose as set forth by the ElektroG, to ensure environmentally sound disposal or recycling of the materials used.

Please contact your local service representative in order to dispose of the product.

2 Instrument Controls and Indicators

R&S®HMC8015 front panel

- 1 Display – 3.5" TFT color display with QVGA resolution (320 pixels x 240 pixels)
- 2 Interactive softkeys – Direct access to all relevant functions
- 3 Function Keys – Operates as a numeric keypad using SHIFT function
 - U ▲ – Increases voltage range manually
 - I ▲ – Increases current range manually
 - VIEW – Switches between graphical and numeric display
 - U ▼ – Decreases voltage range manually
 - I ▼ – Decreases current range manually
 - ACQ – Data acquisition menu for recording data
 - START / STOP – Starts/stops the energy counter
 - RESET – Resets peak values / energy counter
 - MEAS – Logging function / energy counter / limit values
 - HOLD – Stops the update of measurement values
 - NULL – Sets the current display values as zero reference values
 - EXT – Sensor menu and additional functions
- 4 SAVE/RECALL – Saves and recalls/uploads device settings
- 5 SETUP – Gives access to general device settings
- 6 HELP – Integrated help screen
- 7 SHIFT – Activates the numeric keypad
- 8 Universal rotary control knob with arrow keys – Sets the parameters cells (editing keys)

- 9 V jack – Input for voltage measurement
- 10 COM jack – Shared measuring input for voltage and current measurement
- 11 A jack – Input for current measurement
- 12 IN/COM jacks – Sensor input for external shunts or current probes
- 13 USB port – USB host port for USB flash drives when saving parameters
- 14 POWER – ON/OFF for standby mode

R&S®HMC8015 rear panel

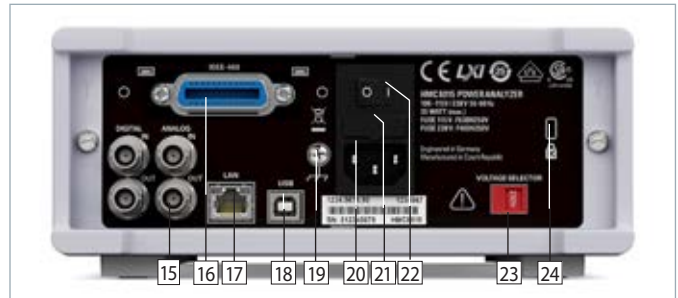

Fig. 2.2: R&S®HMC8015 rear panel.

- 15 Digital / Analog IN/OUT – Digital / Analog inputs and outputs for Pass/Fail sorting and limit values
- 16 IEEE-488 (GPIB) interface (optional) – Installation available at factory only
- 17 Ethernet (LAN) interface
- 18 USB interface
- 19 Ground terminal
- 20 Uncooled IEC plug
- 21 Fuse
- 22 Power switch
- 23 Supply voltage selector switch (115 V or 230 V)
- 24 Kensington lock

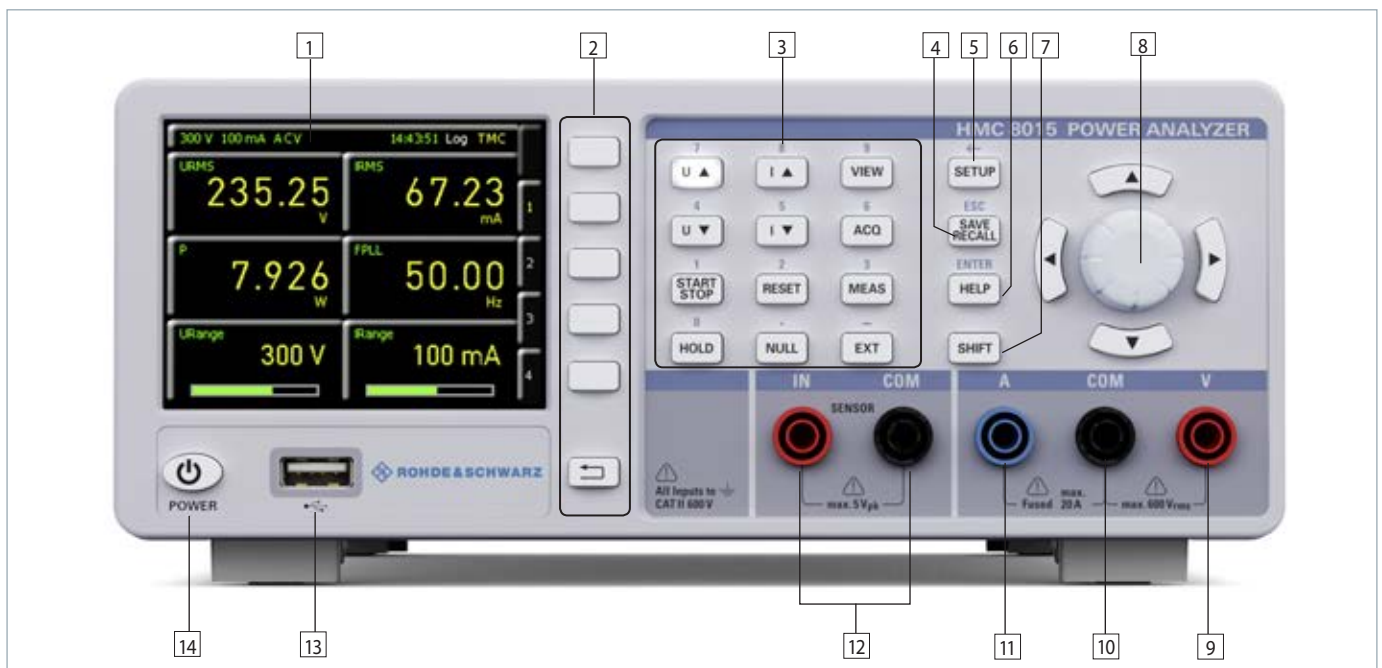

Fig. 2.1: R&S®HMC8015 front panel.

3 Options/Upgrade Vouchers

The R&S®HMC8015 has available options that increase the application scope of the instrument. Options and upgrade vouchers can be combined. The R&S®HOC151 Advanced Analysis, the R&S®HOC152 Advanced IO resp. the R&S®HOC153 Compliance Test option can both be purchased from the factory with an R&S®HMC8015. In contrast, the R&S®HV151 Advanced Analysis, the R&S®HV152 Advanced IO resp. the R&S®HV153 Compliance Test upgrade voucher enable a subsequent upgrade via a license key. The installed options or upgrade vouchers can be looked up under "Device Information" in the SETUP

Description	R&S®HMC8015 options ¹⁾	R&S®HMC8015 upgrade vouchers ²⁾
Advanced Analysis	R&S®HOC151	R&S®HVC151
Advanced IO	R&S®HOC152	R&S®HVC152
Compliance Test	R&S®HOC153	R&S®HVC153

Table 3.1: Overview of R&S®HMC8015 options/upgrade vouchers

- 1) Only when ordered in combination with a R&S®HMC8015 base unit
- 2) Subsequent activation of R&S®HMC8015 options via upgrade voucher

menu. Table 3.2 shows an overview of the most important optional features. For complete specifications, please refer to the data sheet.

To generate a license key, go to Rohde & Schwarz homepage and enter the voucher code. The license key (SERIALNUMBER.hlk) is an ASCII file and can be opened using a file editor. The key is listed in the file in plain text. Enable

Function	Description	R&S®HMC8015 Base Unit	R&S®HOC151 R&S®HVC151	R&S®HOC152 R&S®HVC152	R&S®HOC153 R&S®HVC153
P	Active power (W)	•			
S	Apparent power (VA)	•			
Q	Reactive power (var)	•			
LAMBDA	Power factor lambda (λ)	•			
PHI	Phase shift (ϕ)	•			
FU	Frequency value for the voltage (Hz)	•			
FI	Frequency value for the current (Hz)	•			
FPLL	Frequency and phase locked loop recording frequency (Hz)	•			
URMS	True root mean square (RMS) voltage (U_{RMS})	•			
UAVG	Average voltage	•			
IRMS	True root mean square (RMS) current (I_{RMS})	•			
IAVG	Average current	•			
UTHD	Total harmonic distortion U	•			
ITHD	Total harmonic distortion I	•			
WHM, WHP, WH, AHM, AHP, AH	Energy counter (integrator values)	•			
Logging	Data recording (comma-separated values CSV)	•			
USB, Ethernet (GPIB optional – HMC8015-G)	Remote interfaces	•			
UPPeak	Maximum voltage (U_{+pk})		•		
UMPeak	Minimum voltage (U_{-pk})		•		
IPPeak	Maximum current (I_{+pk})		•		
IMPeak	Minimum current (I_{-pk})		•		
PPPeak	Maximum power (P_{+pk})		•		
PMPeak	Minimum power (P_{-pk})		•		
Harmonics mode	Bar graph of 50 harmonics		•		
Waveform mode	Displays the waveform (for one cycle of voltage, current or power data)		•		
Trendchart mode	Current or voltage displayed as signal profile		•		
Inrush mode	Triggered display of a signal profile (single shot)		•		
Sensor input	Input jack for current probe / external shunt			•	
DIN / AIN	Digital / analog inputs and outputs (Bayonet Neill–Concelman BNC)			•	
Limit / PASS-FAIL	Displays limit values			•	
IEC 62301	Standby standard				•
EN 50564	Extended standby standard				•
IEC 61000-3-2	Harmonic current for EMC, CE approval				•

Table 3.2: Feature overview: options/upgrade vouchers

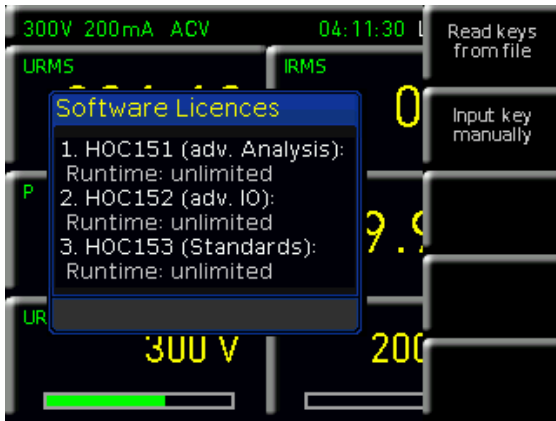

Fig. 3.1: Upgrade menu.

the option in the instrument by either reading the key in automatically or entering it manually. The fastest and easiest method is to read the key in automatically from a USB flash drive. To do this, save the license file to a USB flash drive and then insert the flash drive into the USB port on the instrument front panel. Press the SETUP button and then softkey LICENSE to open the menu for reading in options and upgrade vouchers. Press softkey READ KEYS FROM FILE to open the File Manager. Use the rotary control knob to select the license file, then press softkey LOAD to load the key. The license key is loaded and the option is available after the instrument has been restarted.

Alternatively, the license key can be entered manually. To do this, press softkey INPUT KEY MANUALLY. This opens an input window where the license key can be typed in manually. Once the key has been entered, confirm by pressing softkey ACCEPT. Restart the instrument to enable the option.

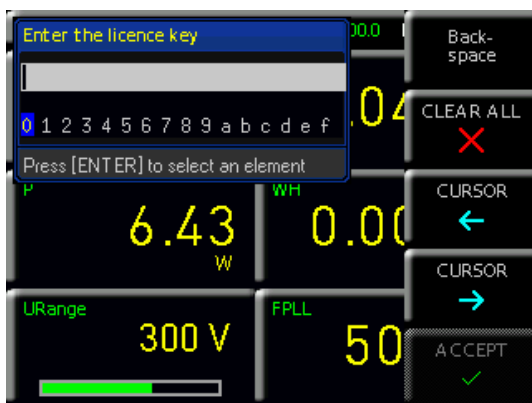

Fig. 3.2: Manually entering the license key.

4 Connecting a Device under Test

4.1 Connecting a Device under Test via Adapter



Fig. 4.1: Connecting HZC815 DE version to R&S®HMC8015.

A device under test (DUT) can easily and securely be connected to the R&S®HMC8015 using the optional HZC815 socket adapter. In this case, the cables enclosed with the HZC815 (length = 25 cm) are connected to the R&S®HMC8015 socket on the front panel. The connection of the socket adapter to the R&S®HMC8015 front panel is determined by the color of the HZC815 accessory cables. The cables on the socket adapter represent an extension of contacts for a standard AC outlet with grounded safety sockets and are used for measuring a DUT. Power is supplied to the HZC815 socket adapter through the uncooled IEC plug on the top of the adapter and a power cord. There are 4 different types of HZC815 available ex factory:

- **HZC815-DE:** DE version; EU socket adapter
- **HZC815-UK:** UK version; UK socket adapter
- **HZC815-US:** US version; US socket adapter
- **HZC815-CHN:** CHN/AUS version; CHN/AUS socket adapter



Fig. 4.2: HZC815 DE, UK, US and CHN version plug adapters.

The HZC815 standard AC grounded safety outlet system is only approved for a 10 A continuous load. A load of 20 A would destroy the adapter.

On the sides of the HZC815 adapter, special faceplates hide mounting screws. The socket adapter can be permanently mounted with these mounting screws if so desired.



Fig. 4.3: HZC815 DE version plug adapter with mounting screws.

4.2 Connecting a Device under Test Directly

The R&S®HMC8015 can measure voltages up to 600 V_{RMS} and currents up to 20 A_{RMS}. In these cases, a device under test (DUT) can be directly connected to the power analyzer using the 4 mm safety jacks on the front panel.

Before the start of each measurement, the signal cables to be used must be checked for damage and wear.

Voltages are measured using the red V jack; currents are measured using the blue A jack. The black COM jack acts here as the shared measuring input for voltage and current measurement.

If the maximum values for current and voltage are exceeded, the R&S®HMC8015 power analyzer is automatically switched off.



If the safety warning "Overcurrent Protection" appears on the screen, then more than 2 A were supplied in the low current range. The unit switches itself off in order to protect the internal shunt. In this case, switch to the automatic range selection (AUTO) or a higher range (> 500 mA) manually.

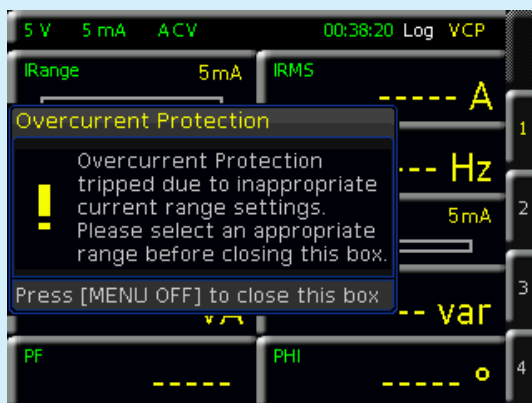

4.2.1 Internal Jack Wiring

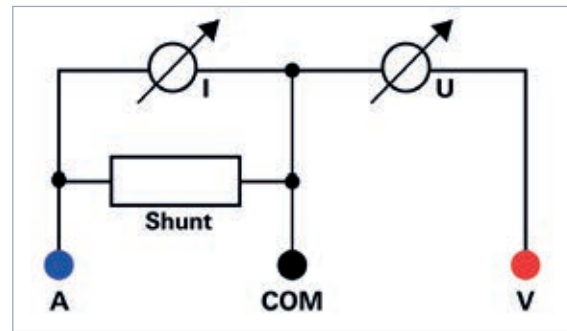

Fig. 4.4: Internal wiring of A, V and COM jacks.

The 4 mm A, V and COM safety jacks on the front panel are not electrically isolated and separate from each other, and therefore offer several methods for measuring a DUT:

- Voltage-based measurement
- Current-based measurement
- Measurements via external shunt / current probe

4.2.2 Voltage-Based Measurement

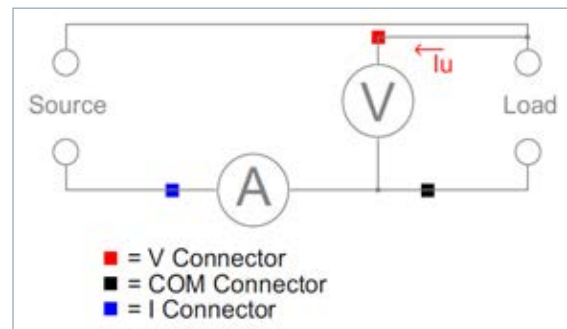

Fig. 4.5: Voltage-based measurement.

Voltage-based measurement is typically used with high currents, since the voltage drop at the shunt increases as the current increases. The voltage U is correctly measured at the load.



Fig. 4.6: Voltage-based measurement, wiring example.

4.2.3 Current-Based Measurement

Current-based measurement is preferred with low currents and high voltages, because it prevents current flowing through the voltage measuring jack from going through the shunt, which would falsify the reading. With this measurement type, the current reading must be inverted (IN-

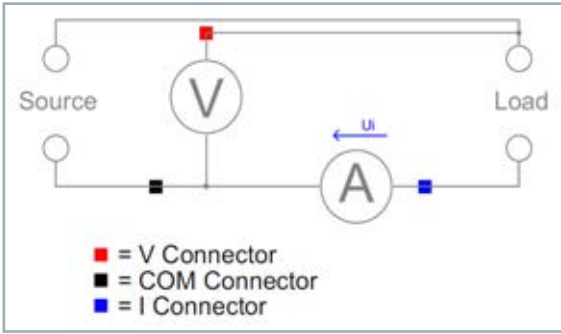

Fig. 4.7: Current-based measurement.

VERT) using the ACQ menu and softkey menu CURRENT. In addition, the I and COM cables need to be reversed (see Fig. 4.8).



Fig. 4.8: Current-based measurement, wiring example.

4.2.4 Measurements with an External Shunt or Clamp-on Current Probe

The 4 mm safety jacks IN and COM are used for making measurements with an external shunt or clamp-on current probe. Safety plugs connect the shunt or clamp-on probe directly to the jacks. Accessories such as HZC50 or HZC51 can be used for the clamp-on probe.



Fig. 4.9: HZC51 Clamp-on current probe.

⚠ The connection of a clamp-on probe through a BNC adapter is not allowed, since depending on the polarity of the voltage, the measuring voltage may be present across the BNC plug coupling.

4.3 Sensor Menu

The Sensor configuration menu is opened via the EXT menu and the softkey menu SENSOR. Press softkey ACTIVATE to activate (ON) or deactivate (OFF) the sensor measurement. When the sensor measurement is activated (ON), the automatic current measurement (AUTO) is deactivated (if it was activated previously).

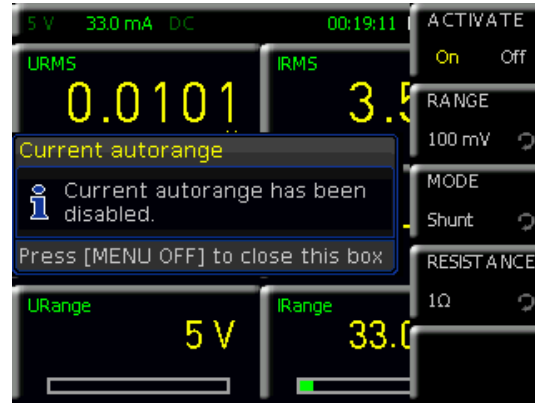

Fig. 4.10: Sensor menu.

The softkey ACTIVATE activates the sensor inputs IN and COM on the instrument front panel (hardware switch).

Use the softkey RANGE and the rotary control knob to select the maximum measuring range for the measured voltage. The available settings are 100 mV, 1 V and 4 V. As a rule, the 100 mV range is appropriate for measurements on shunts, while 1 V and 4 V are used for measurements with a current probe. This setting is referenced to the peak value.

Example for "Shunt":

Set RESISTANCE to 1 Ω.

Set RANGE to 4 V.

Convert as follows:

$$1 \text{ V} = 1 \text{ A} \rightarrow 4 \text{ V divided by CF3} = 1.33 \text{ A.}$$

Use the cell configuration to display this power range as IRANGE on the screen.



Fig. 4.11: Example of a sensor.

Use softkey MODE and the rotary control knob to select the sensor mode. The available modes are SHUNT (to connect an external shunt) and CLAMP (to connect a current probe, e.g. HZC50 / HZC51). The Sensor menu

changes dynamically to match the selected sensor mode. In sensor mode SHUNT, softkey RESISTANCE is used to enter the value of the externally connected shunt in ohms. Select the value using the rotary control knob or press the SHIFT button to input the value numerically. If you entered the value numerically, press the appropriate unit on the softkey menu to confirm the value. Once the shunt value is entered, all measured values (current, power and values derived from these) can be calculated correctly and displayed. Manual calculations are no longer necessary. The data from the external shunt is converted to the correct measured values internally.

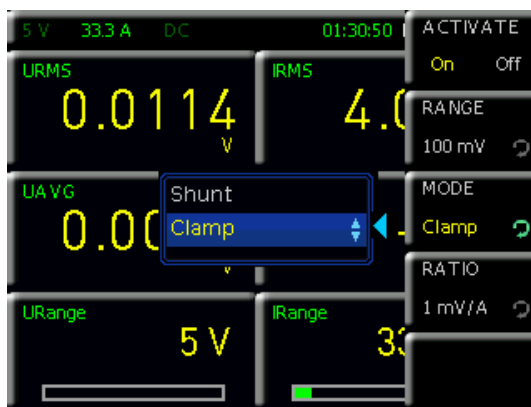

Fig. 4.12: Sensor mode.

In sensor mode CLAMP, softkey RATIO and the rotary control knob are used to define a conversion factor. This factor defines how many millivolts the sensor transmits when a current of 1 A is applied. Once the factor is entered, all measured values (current, power and values derived from these) can be calculated correctly and displayed. Manual calculations are no longer necessary. Available factors are 1 mV/A, 10 mV/A and a user-defined value (USER). The conversion factors 1 mV/A and 10 mV/A are appropriate for the current probes HZC50 and HZC51, for example. If you are using a current probe from a different manufacturer, use the rotary control knob to select the factor or use the SHIFT button to input the factor numerically.

5 Setting Parameters

5.1 Using the Instrument for the First Time

Pay particular attention to the safety instructions indicated above when using the instrument for the first time!

After connecting the uncooled IEC power cable and operating the power switch on the rear panel, the unit can be switched on by pressing the POWER button on the front panel. A help screen appears automatically. If you do not want to see the help screen, it can be hidden with the HIDE function. With the HIDE FOREVER softkey, the help screen feature will be disabled and no longer automatically displayed after restarting. After doing this, the help function can only be opened using the HELP button.

Whenever the power analyzer is switched on, it is in the same mode as when it was last shut down. All device settings are stored in nonvolatile memory (NVM) and retrieved when restarting.

5.2 Screen Display Description

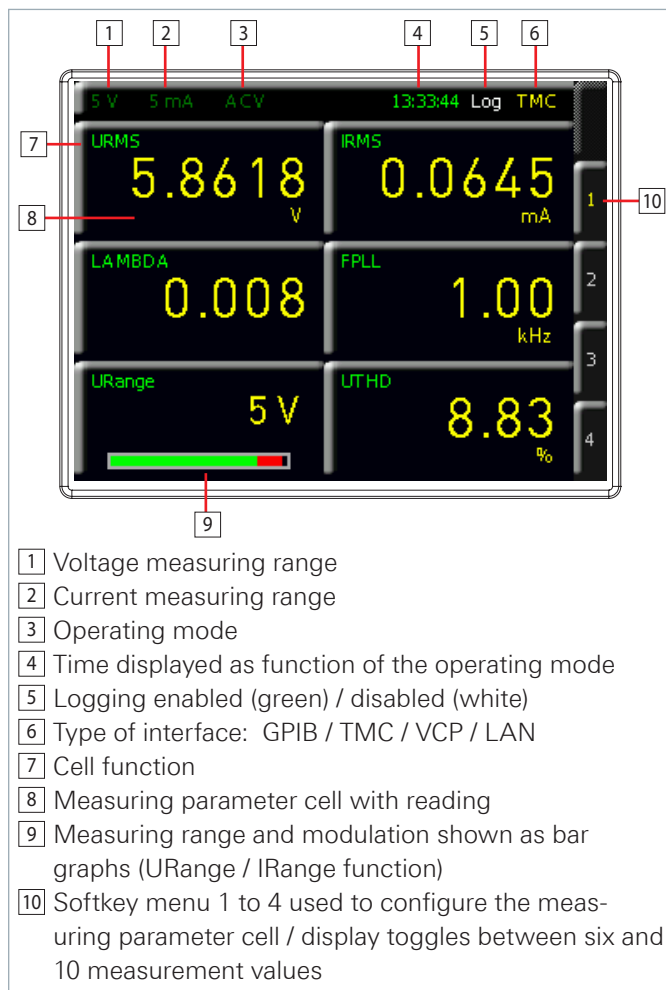

- 1 Voltage measuring range
- 2 Current measuring range
- 3 Operating mode
- 4 Time displayed as function of the operating mode
- 5 Logging enabled (green) / disabled (white)
- 6 Type of interface: GPIB / TMC / VCP / LAN
- 7 Cell function
- 8 Measuring parameter cell with reading
- 9 Measuring range and modulation shown as bar graphs (URange / IRange function)
- 10 Softkey menu 1 to 4 used to configure the measuring parameter cell / display toggles between six and 10 measurement values

Fig. 5.1: Screen display description.



Fig. 5.2: Help function.

5.3 Multifunction Softkeys

The menu field that appears on the screen can be manipulated using the softkeys on the right side of the screen. After a menu is activated by using the function keys on the front panel, control and configuration of the menu functions is done by using the softkeys. If a device function is not available within a specific setting (e.g. if an option or upgrade voucher is not installed), then the corresponding softkey is disabled and the caption is grayed out. Close a menu or jump back one menu level using the softkey  at the very bottom. In addition, the Quick Menu and the softkeys 1 to 4 can be used to configure the display of the measuring parameter cells. If the softkey of the already active configuration page is pressed again, it is possible to toggle between a display of six and 10 parameter cells. Each cell can be fully customized. Up to four configuration menus are available.

5.4 Configuring the Operating Mode from a List of Measuring Parameter Options ("Cells")

The individual functions and operating modes of the power meter can be selected using the buttons on the front panel. To select a device function, the corresponding function key is pressed. The white LED inside the key is lit as an indication that the function is active. The editing of a cell is activated by pressing on the rotary control knob or one of the arrow keys. The first cell on the top left is highlighted in blue. The relevant parameter cell can then be selected using the rotary control knob or the arrow keys. Once a parameter cell is selected, the parameter list

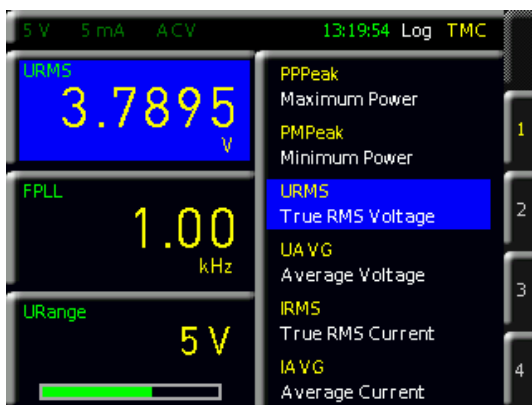

Fig. 5.3: Selecting the measurement function.

can be opened by pressing the rotary control knob again. When a measuring parameter has been selected, it can be confirmed by pressing the rotary control knob, or after 20 seconds without input, the unit will automatically return to the previous screen (see Section 9.3.5 Key Fallback Time).

5.5 Readout Display

The R&S®HMC8015 power analyzer has a TFT color display. The screen is divided into two sections. The first section is the status bar, in which the currently active modules and interface information are displayed. Figure 5.1 presents a general overview of the power meter's split screen with all possible function displays and their descriptions.



Fig. 5.4: Readout display with six active cells.

The field of cells is variable and dependent on the operating mode. In Numeric mode (set by default), typical numeric measurement values, such as power, voltage, current etc., are displayed. By contrast, in Harmonics mode (HOC151 option resp. HVC151 voucher required), the harmonics of the signals are displayed as bar graphs. Each mode has its own menu structures, which can be configured by using the softkeys. By default, the Numeric display consists of either 6 or 10 cells with 4 different configuration pages.

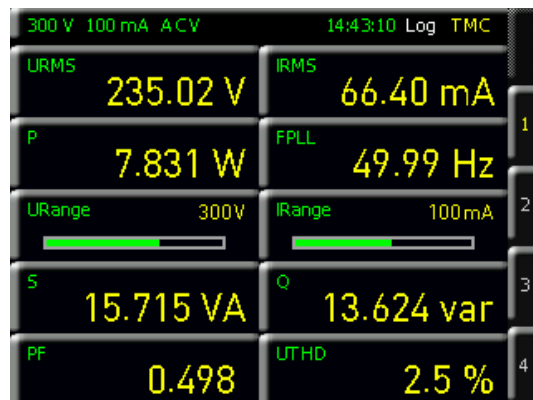

Fig. 5.5: Readout display with 10 active cells.

With the HOLD function, the current measurement results are paused and shown on the display. Therefore when the HOLD button is pressed (button is lit), the particular measurement values are frozen on the display. The data recording is then running in the background. If the HOLD button is pressed again (LED turned off), the function is deactivated.

Using the NULL button, the current readings are taken as reference values and any deviation from them is shown on the display. If the NULL function is activated, the LED inside the button is lit. To deactivate the NULL function, press the button again (LED turned off).

If the device shows only dashes “---” on the display, the R&S®HMC8015 could not determine a valid frequency. This can occur, for example, when the AC function was selected and the signal amplitude is too small or when the measuring range has been set too high.

5.6 Selecting the Measuring Range

The individual functions and operating modes of the R&S®HMC8015 unit can be selected using the buttons on the front panel. Basic functions, such as voltage or current measuring range, can be selected through the corresponding function keys. Using the U▲, I▲, U▼ and I▼ keys, the measuring range can be increased or decreased manually. U▲ or I▲ switches to the next higher, U▼ or I▼ to the next lower voltage or current measuring range.



Fig. 5.6: Example of measuring range display.

Push long the U▲, I▲, U▼ and I▼ keys to activate the automatic measurement range mode.

Using the URANGE or IRANGE measurement parameters, the modulation of the selected measuring range can be graphically displayed (bar graph) on the screen. If the measuring range is manually adjusted with the U▲, I▲, U▼ and I▼ keys, the bar graph is changed accordingly. A red measuring range bar indicates that the measuring range of the incoming signal is too small.

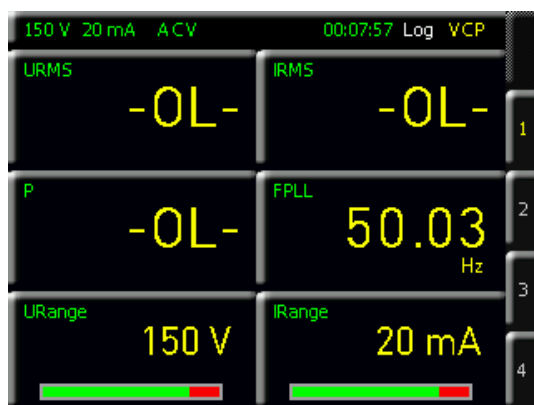

Fig. 5.7: Selecting the measurement function.

If, at crest factor 3, the instrument is in a current measuring range less than 200 mA and automatic current range selection is activated, then the data acquisition hardware automatically switches to the highest current measuring range for any large overcurrent (e.g. 2 A).

In automatic range selection mode, this leads to a switch to the next higher range if the signal readings exceed 120 % of the current measuring range. The unit switches to the next lower range if 0.6 s have elapsed since the last range change and the RMS reading is within 95 % of the next smaller measuring range.

In the case of manual range selection, if the applied value is too large, the display will show the message “OL” (overload).

Moreover, by using the ACQ menu, the automatic measuring range selection (AUTORANGE) for current or voltage can be activated (ON) or deactivated (OFF) in the VOLTAGE or CURRENT softkey menu. The manual range selection is automatically disabled when using AUTORANGE. If the automatic measurement range selection is deactivated (AUTORANGE OFF), the measurement range for current or voltage can be selected manually via softkey RANGE and the rotary control knob.



Fig. 5.8: Manual measurement range selection via ACQ menu

6 Instrument Functions

6.1 Measurement Parameters

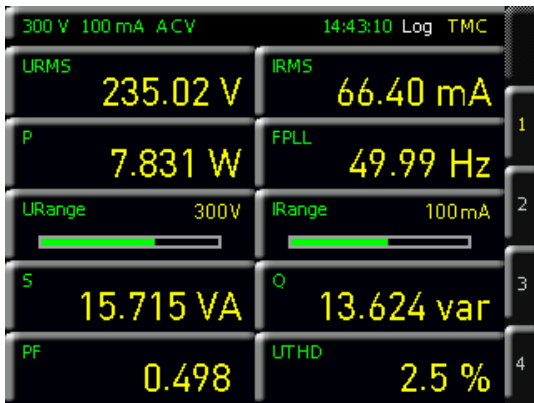

Fig. 6.1: R&S®HMC8015 readout display.

In NUMERIC mode, the instrument screen provides an overview of the measurement values. The numeric values displayed on the instrument screen are instantaneous val-

R&S®HMC8015 base unit	
P	Active power (W)
S	Apparent power (VA)
Q	Reactive power (var)
LAMBDA	Power factor lambda (λ)
PHI	Phase shift (φ)
FU	Frequency value for the voltage (Hz)
FI	Frequency value for the current (Hz)
FPLL	Frequency and phase locked loop recording frequency (Hz)
URMS	True root mean square (RMS) voltage (U_{RMS})
UAVG	Average voltage
IRMS	True root mean square (RMS) current (I_{RMS})
IAVG	Average current
UTHD	Total harmonic distortion U
ITHD	Total harmonic distortion I
Wh+	Positive watt hours
Wh-	Negative watt hours
Wh	Sum of positive and negative watt hours
Ah+	Positive ampere hours
Ah-	Negative ampere hours
Ah	Sum of positive and negative ampere hours
R&S®HMC8015 base unit + HOC151 option /HVC151 voucher	
UPPeak	Maximum voltage (U_{+pk})
UMPeak	Minimum voltage (U_{-pk})
IPPeak	Maximum current (I_{+pk})
IMPeak	Minimum current (I_{-pk})
PPPeak	Maximum power (P_{+pk})
PMPeak	Minimum power (P_{-pk})
R&S®HMC8015 base unit + HOC152 option /HVC152 voucher	
DIN	Digital input value (digital IN)
AIN	Analog input value (analog IN)
Limit N	Limit display

Table 6.1: Overview of measurement functions

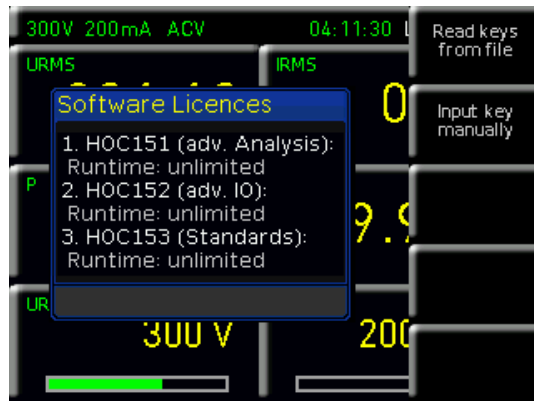

Fig. 6.2: Option / upgrade voucher info box.

ues that are constantly updated. If an instrument function is grayed out in the menu, the purchase of an option/upgrade voucher is required in order to unlock this feature. If the softkey of the grayed-out function is pressed, then an info box appears on the screen with the required option/upgrade voucher (see Chapter 3).

6.2 Display Modes (VIEW Menu)



Fig. 6.3: VIEW menu.

The R&S®HMC8015 power analyzer includes five different display modes for the display of measurement results; these can be enabled by activating options/upgrade vouchers. The display modes can be selected using the VIEW menu. The following display modes are available:

■ Numeric mode: (default display)

Numeric display, toggles between six and ten measurement parameters presented as cells with four different configuration pages; this provides a quick overview of the individual, configurable measurement value cells.

■ Harmonics mode:

Bar graph of the first 50 harmonics; this represents the density of voltage / current as a percentage, absolute value or as a list. HARMONICS mode is only available in conjunction with the HOC151 option or the HVC151 upgrade voucher.

■ Waveform mode:

Displays the waveform (for one cycle of voltage, current or power data). WAVEFORM mode is only available in conjunction with the HOC151 option or the HVC151 upgrade voucher.

Trendchart mode:

Current or voltage displayed as a signal profile (similar to the roll mode in an oscilloscope). TRENDCHART mode is only available in conjunction with the HOC151 option or the HVC151 upgrade voucher.

Inrush mode:

Triggered display of a signal profile (single shot); INRUSH mode is only available in conjunction with the HOC151 option or the HVC151 upgrade voucher.

6.2.1 Harmonics Mode

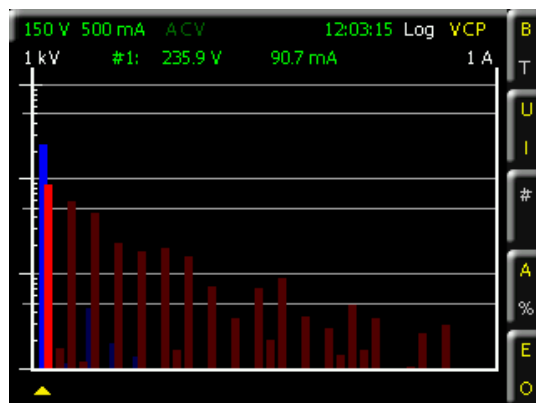

Fig. 6.4: Logarithmic readout display in Harmonics mode.

FFT is used to calculate the RMS value and phase angle of the harmonics. This includes a calculation of the first 50 harmonics (100 kHz max.). Instead of the total RMS value, the display shows the voltage level or the current level of the individual harmonics selected using the cursor. The cursor, which appears in the form of a small triangle under the indicator bar, is moved using the rotary control knob. The cursor, which appears in the form of a small triangle under the indicator bar, is moved using the rotary control knob to select the appropriate harmonic. The selection is shown as a yellow bar (see Fig. 6.5). The voltage levels (softkey SOURCE U – Quick Menu U) are displayed as blue bars and the current levels (softkey SOURCE I – Quick Menu I) as blue bars. Using SCALING (Quick Menu A or %), it is possible to select a scaling factor for the signal in the Y-axis with reference to the fundamental (ABS or %). The measurement diagram is displayed logarithmically on the screen so that even the smallest signal details are visible.

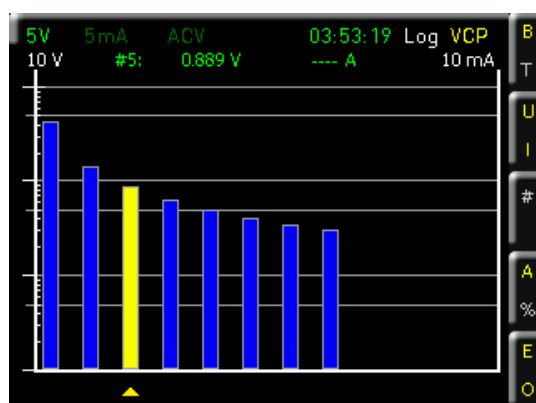



Fig. 6.5: Harmonics selection with rotary control knob

Harmonics					VIEW SELECT	
Order	U[V]	Phi(U)[°]	I[A]	Phi(I)[°]	Bar	Tab
1	0.020	0.0	0.041m	-0.0		
2	3.421	46.0	0.001m	-82.7		
3	0.000	-54.9	0.000m	3.6		
4	1.145	-41.8	0.001m	51.3		
5	0.000	65.9	0.001m	76.1		
6	0.693	50.4	0.001m	-48.6		
7	0.000	-44.9	0.000m	-29.0		
8	0.500	-37.2	0.001m	35.2		
9	0.000	52.9	0.000m	65.4		
10	0.394	55.4	0.001m	21.9		
11	0.000	-9.6	0.000m	-24.5		
12	0.326	-31.9	0.000m	-34.2		

Fig. 6.6: Tabular display in Harmonics mode.

The softkey VIEW SELECT (Quick Menu B or T) can be used to switch the harmonics display between a bar graph (BAR) or a table (TAB). Unlike the bar graph, the tabular display includes both the magnitude and phase. The softkey NUMBER (Quick Menu #) and the rotary control knob can be used to display the number of harmonics included in the FFT calculation. The softkey SUBSET (Quick Menu E or O) can be used to define what harmonics are to be used in the calculation (EVEN, ODD or all). The voltage U or current I or both can be selected as the source for the FFT calculation (softkey SOURCE).

The FFT is calculated continuously. Settings made using softkeys affect only the display of values on the screen.

Pressing the bottommost softkey  closes the HARMONICS menu and opens a Quick Menu while the mode remains active. This permits convenient control of the harmonics settings via the Quick Menu. Pressing the VIEW button and then selecting display mode NUMERIC closes Harmonics mode and returns to the default display mode.

6.2.2 Waveform Mode

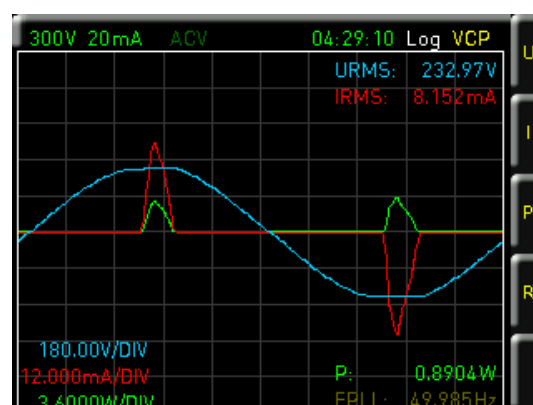



Fig. 6.7: Quick Menu in Waveform mode.

The WAVEFORM display mode can be used to display the voltage, current and power simultaneously as a trace on the screen (hardware-based triggering). Exactly one signal period is displayed in the measurement diagram and automatically scaled to the measuring range final value (100kHz max.). Softkeys U, I and P are used to display or

hide the traces for voltage (blue), current (red) and power (green). In addition, softkey R (Readouts) can be used to display statistical values, including U_{RMS} , I_{RMS} , FPLL (= trigger frequency) and P (power). In addition, the left side of the display shows the resolution of the graticule used for the voltage, current and power.

Pressing the bottommost softkey  closes the WAVEFORM menu and opens a Quick Menu while the mode remains active. This permits convenient control of the settings via the Quick Menu. Pressing the VIEW button and then selecting display mode NUMERIC closes Waveform mode and returns to the default display mode.

6.2.3 Trendchart Mode

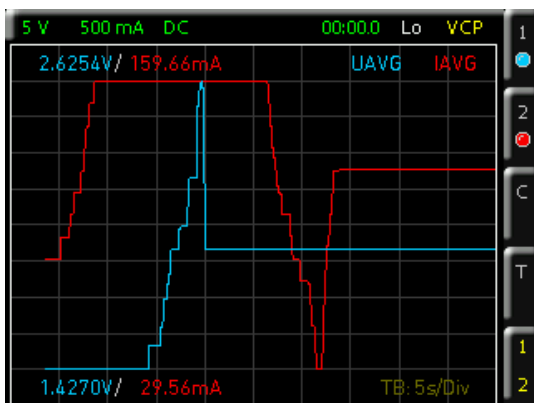

Fig. 6.8: Trendchart mode.

TRENDCHART display mode is used to view two selected values over time. The trend display is configured on the right pane of the screen. Softkeys SRC 1 (Source 1 – Quick Menu 1) and SRC 2 (Source 2 – Quick Menu 2) are used to select the values (sources). The following measurement functions are available as sources:

Function	Description
P	Active power (W)
S	Apparent power (VA)
Q	Reactive power (var)
PHI	Phase shift (ϕ)
FU	Frequency value for the voltage (Hz)
FI	Frequency value for the current (Hz)
FPLL	Frequency and phase locked loop recording frequency (Hz)
URMS	True root mean square (RMS) voltage (U_{RMS})
UAVG	Average voltage
IRMS	True root mean square (RMS) current (I_{RMS})
IAVG	Average current
UTHD	Total harmonic distortion U
ITHD	Total harmonic distortion I
DIN	Digital input value (digital IN)
AIN	Analog input value (analog IN)

Table 6.2: Overview of SOURCE measurement functions in Trendchart mode

Acquisition of the trend is restarted any time the measurement function is changed. The trace scaling is set automatically on the screen and cannot be changed. The softkey TIME BASE (Quick Menu TB) can be used to select

the temporal resolution per scale division. The available values are 5 s/Div, 10 s/Div, 1 min/Div or 10 min/Div. The existing trace data is deleted and a new recording started whenever the time resolution is changed. The softkey CLEAR (Quick Menu CLR) deletes the trace data from the screen and starts a new acquisition. VISIBLE (Quick Menu 1|2) is used to activate Source 1 and Source 2 (yellow) or to deactivate them (white).

Pressing the bottommost softkey  closes the TRENDCHART menu and opens a Quick Menu while the mode remains active. This permits convenient control of the settings via the Quick Menu. Pressing the VIEW button and then selecting display mode NUMERIC closes Trendchart mode and returns to the default display mode.

6.2.4 Inrush Mode

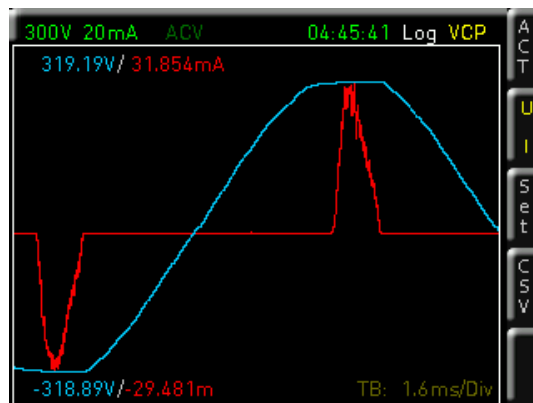

Fig. 6.9: Inrush mode.

INRUSH display mode uses an internal hardware buffer to trigger acquisition of a rare event and to output it to the display (similar to the single shot function found on oscilloscopes). This might be used to acquire inrush currents on loads, for example. After an event occurs, the current and voltage trends are acquired. The softkey VISIBLE (the Quick Menu U or I) is used to activate (yellow) or deactivate (white) the voltage or current trace. Under SETTINGS (Quick Menu SET), the trigger is set to one of these two values, or it can be selected manually. A threshold (softkey LEVEL) can also be set, as well as the offset between

Sampling rate	Acquisition time
500.00 ksample	16 ms
250.00 ksample	32 ms
125.00 ksample	65 ms
62.50 ksample	130 ms
31.25 ksample	260 ms
15.63 ksample	520 ms
7.81 ksample	1 s
3.91 ksample	2 s
1.95 ksample	4 s
976.56 sample	8 s
488.28 sample	16 s
244.14 sample	33 s
122.07 sample	67 s

Table 6.3: Overview of sampling rates

the rising and falling edges (softkey SLOPE). At the full sampling rate, the acquisition runs for 16 ms (softkey ACQ. TIME). The sampling rate can also be varied to permit acquisition of signal sequences of over a minute (see Table 6.3).

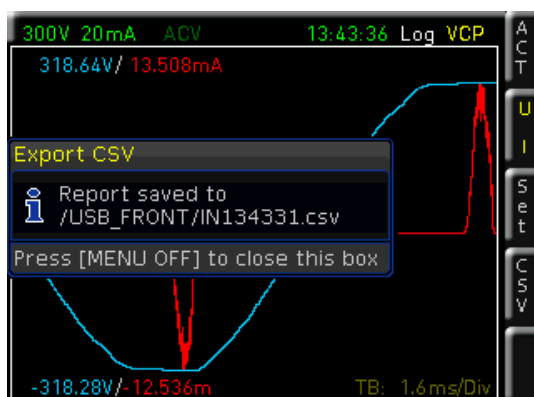

Fig. 6.10: CSV export of an Inrush trace

The trace display does not update dynamically. Instead, it must be updated manually by pressing softkey ACTIVATE (ON) (Quick Menu ACT). The trace is updated each time the button is pressed (single shot). The Inrush display cannot be zoomed. A maximum of 8000 measurement values each for current and voltage can be acquired. The softkey EXPORT CSV (Quick Menu CSV) is used to export the inrush trace as a CSV and save it to a connected USB flash drive. The data is saved by pressing the softkey EXPORT CSV or CSV. The filename contains the designation of the trace (IN = Inrush) and the time when it was saved. The CSV file contains the maximum number of current and voltage points (8000 points) with the corresponding time.

Excerpt from an inrush CSV example:

```
#Manufacturer;Rohde&Schwarz
#Device;HMC8015
#Serial No.;012345678
#Version;01.300
#Acquisition time;0.016384
#Trigger;Manual
#Number of points;8192
```

```
Time[s];Voltage[V];Current[A]
0;6.6744;-5.49333e-05
2e-06;6.48213;-4.39467e-05
4e-06;6.20746;-5.67644e-05
6e-06;6.15253;-4.57778e-05
8e-06;5.9328;-5.12711e-05
1e-05;5.768;-5.67644e-05
1.2e-05;5.57573;-4.57778e-05
1.4e-05;5.38347;-5.49333e-05
1.6e-05;5.1912;-4.02844e-05
```

...

Pressing the bottommost softkey  closes the INRUSH menu and opens a Quick Menu while the mode remains active. This permits convenient control of the settings via the Quick Menu. Pressing the VIEW button and then selecting display mode NUMERIC closes Inrush mode and returns to the default display mode.

6.2.5 Power Software Module (HMEexplorer)

A Power software module from the HMEexplorer PC Software is also available for documenting the individual display modes (see example in Fig. 6.11). In this module, the individual display modes can be started in parallel and the data can be logged, among other functions. All device functions available on the front panel of the device can be

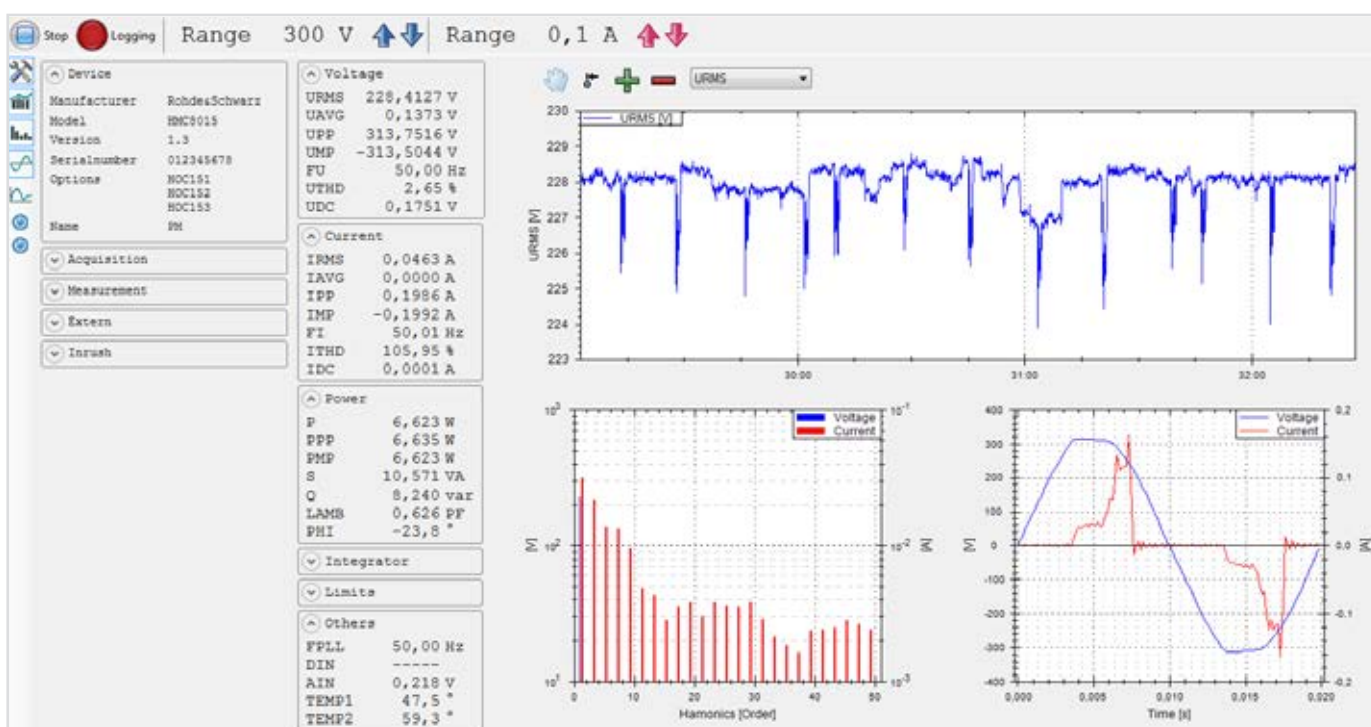

Fig. 6.11: Example display of HMEexplorer software Power module

reproduced using the Power software module. You can find additional information on the Power software module in the HME Explorer Software Manual on the Rohde & Schwarz website.

6.3 Compliance Test (only with option HOC153 / voucher HVC153)

The integrator function must be deactivated before a compliance test can be correctly performed.

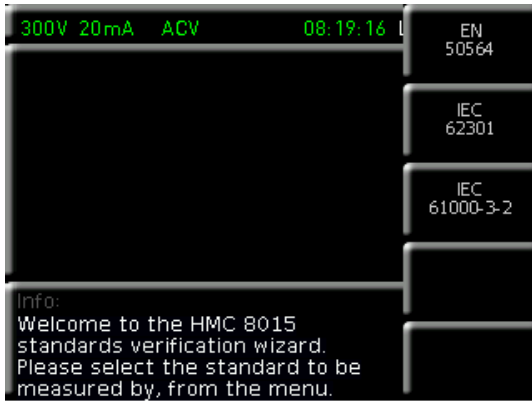

Fig. 6.12: Compliance Test menu

Wizards have been implemented to allow standalone measurement for the standards IEC 62301 (Standby mode), EN 50564 (Extended Standby mode) and IEC 61000-3-2 (Harmonic Current for EMC, CE approval) without a PC. The results are displayed in a table on the screen and can be saved to a USB flash drive in HTML format. The compliance test menu is opened with the key MEAS and the softkey STANDARDS. The wizard is started by selecting the appropriate standard. The wizard goes step-by-step through all necessary settings. The softkey PROCEED confirms the wizard entries and starts the next wizard step. Jump back one menu level using the softkey at the very bottom.

Manually changing the measuring range and the functions in the ACQ menu are disabled during the compliance test.

6.3.1 EN 50564 / IEC 62301

The compliance test menu is opened with the key MEAS and the softkey STANDARDS. The wizard is started by selecting the EN 50564 or IEC 62301 standard. The softkey REGION and the rotary control knob can be used to select from the following regions:

- ▮ Europe
- ▮ USA & CA
- ▮ Japan (E = East / W = West)
- ▮ China
- ▮ AU (Australia) & NZ (New Zealand)
- ▮ Custom (user-defined setting)

The settings for the supply voltage (softkey VOLTAGE) and the power frequency (softkey FREQUENCY) are automatically set as a function of the selected region. In addition, a user-defined region setting (CUSTOM) can be used.

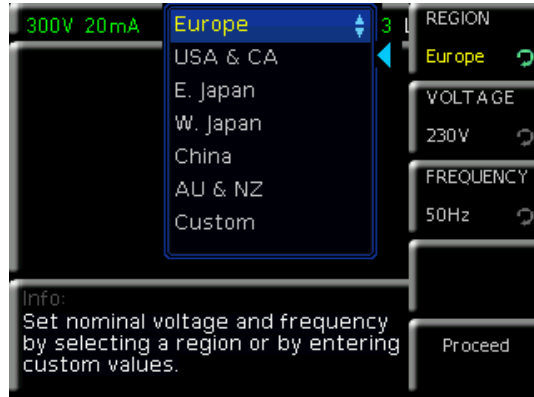

Fig. 6.13: Settings menu EN 50564

If the CUSTOM region is selected, the voltage (softkey VOLTAGE) and frequency (softkey FREQUENCY) can be set manually. In the next wizard step, the crest factor of the current signal can be selected using the softkey CREST FACT. The crest factor ranges between 3 and 6. When changing the crest factor, the measuring range (softkey RANGE) is adjusted automatically.

The consumption pattern can be defined using the softkey PATTERN. The following functions can be selected using the rotary control knob:

- ▮ **Static:** The current drain does not vary.
- ▮ **Variable:** The current drain is irregular or random.
- ▮ **Cyclic:** The current drain is periodic and repeats in specific time intervals.

If the CYCLIC function is selected, a cycle time can be chosen using the softkey CYCLE, the rotary control knob and the arrow keys. The cycle time can be set from 00:00:01 (1s) to 02:00:00 (2h). The Trendchart mode can be used for more accurate analyses. The next wizard step uses a graphic to show how to connect the HZC815 adapter.

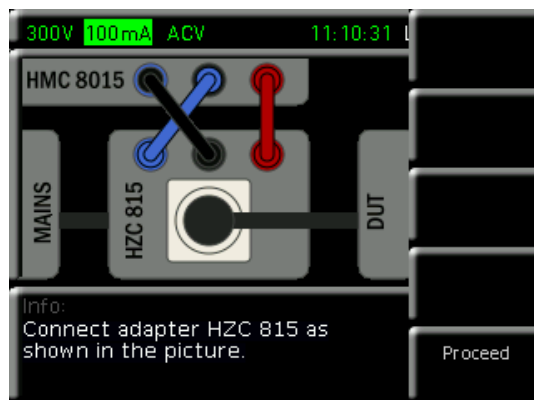

Fig. 6.14: HZC815 connection example EN 50564

Once all relevant settings are complete, pressing the softkey START begins the compliance measurement. Depending on the standard selected, the values for the total harmonic distortion (U_{THD}), the crest factor for the voltage (U_{CF}), the RMS voltage (U_{RMS}) and the frequency (FPLL) are recorded. In addition, the average power (P_{AVG}), the power factor (PF) and the power deviation (P_{DEV}) are measured as reference values. Power deviation P_{DEV} is unitless and

is used to estimate the power consumption stability. The stability criterion is satisfied if $P_{DEV} \leq 1$.

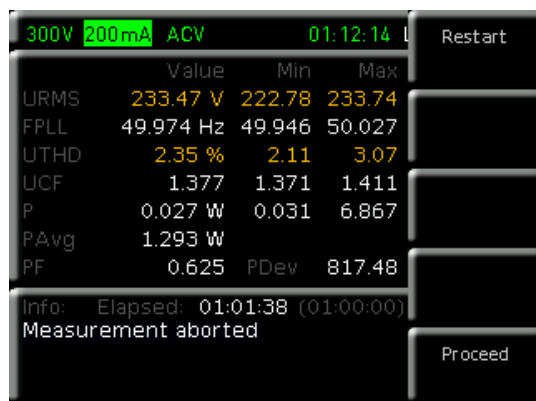

Fig. 6.15: Compliance Test measurement example EN 50564

If the measured values exceed the specification (see Fig. 6.15), they are shown in yellow. Please see the appropriate standard for the harmonic content of the supply voltage and the required crest factor of the test voltage. After the measurement completes automatically (or after it is canceled using the softkey ABORT), the measured values can be saved in HTML format to a connected USB flash drive using the softkeys PROCEED and SAVE HTML.

If a test report has been saved in HTML format to a USB flash drive and the file has been opened using a web browser on the PC, JavaScript must be enabled or the measured values will not display.

The compliance measurement is completed using the softkey FINISH. The measurement can be started again using RESTART. Pressing the key VIEW and then selecting display mode NUMERIC closes Compliance mode and returns to the default display mode.

6.3.2 IEC 61000-3-2

The standard IEC 61000-3-2 tests the harmonic currents for all single-phase devices with <16A, which are intended for connection to a public low voltage system. Thus, this standard is part of the EMC / CE examination. The compliance test menu is opened with the key MEAS and the softkey STANDARDS. The wizard is started by selecting the IEC 61000-3-2 standard. The softkey REGION and the

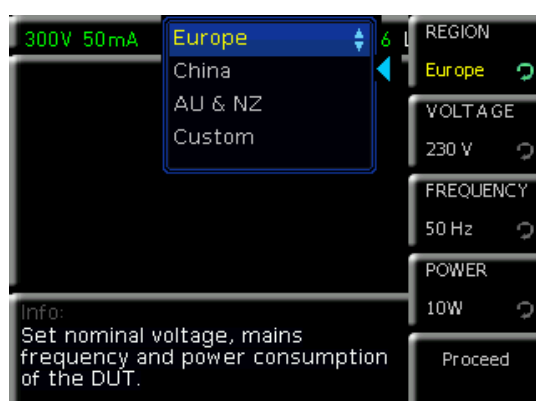

Fig. 6.16: Settings menu IEC 61000-3-2

rotary control knob can be used to select from the following regions:

- ▮ Europe
- ▮ China
- ▮ AU (Australia) & NZ (New Zealand)
- ▮ Custom (user-defined setting)

The settings for the voltage (softkey VOLTAGE) and frequency (softkey FREQUENCY) are automatically set as a function of the selected region. In addition, a user-defined region setting (CUSTOM) can be used. If the CUSTOM region is selected, the voltage (softkey VOLTAGE) and frequency (softkey FREQUENCY) can be set manually. In addition, the nominal power of the DUT is set using the softkey POWER. This value is necessary for calculating the limits. As a rule, the nominal power is displayed on the power supply or on the rear panel of the DUT. An appropriate current range is selected automatically.

In the next wizard step, the appropriate device class can be selected using the corresponding softkey (marked in yellow). Devices are classified as follows:

Class A:

- ▮ Household appliances (excepting class D devices)
- ▮ Stationary electric tools
- ▮ Lighting equipment (with dimmer)
- ▮ Audio equipment
- ▮ Other equipment that is not classified as class B, class C or class D

Class B:

- ▮ Portable electric tools
- ▮ Non-professional arc welding equipment

Class C:

- ▮ Lighting equipment (without dimmer)

Class D:

- ▮ Personal computers and screens (monitors)
- ▮ Televisions and radio receivers
- ▮ Refrigerators and freezers with variable drive systems

The current drain pattern can be defined using the softkey PATTERN. The following functions can be selected using the rotary control knob:

- ▮ **Static:** The current drain does not vary.
- ▮ **Variable:** The current drain is irregular or random.
- ▮ **Cyclic:** The current drain is periodic and repeats in specific time intervals.

If the CYCLIC function is selected, a cycle time can be chosen using the softkey CYCLE, the rotary control knob and the arrow keys. The cycle time can be set from 00:00:01 (1 s) to 01:00:00 (1 h) in 1 second increments. The Trendchart mode can be used for more accurate analyses. The next wizard step shows how to connect the HZC815 adapter using a graphic.

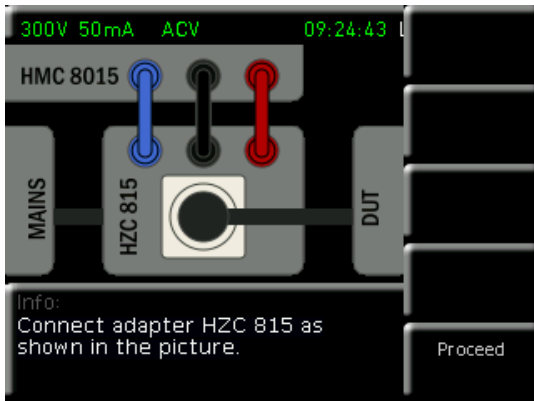

Fig. 6.17: HZC815 connection IEC 61000-3-2

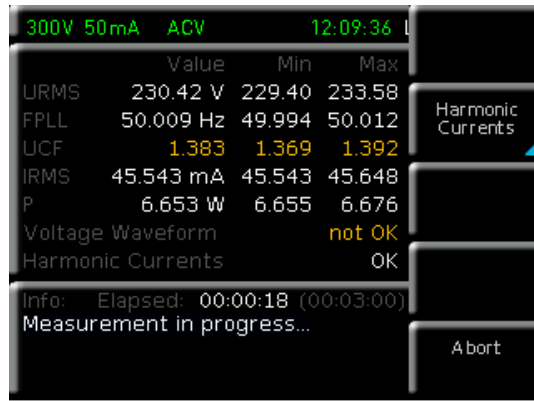

Fig. 6.19: Compliance Test measurement IEC 61000-3-2

Once all relevant settings are complete, pressing the softkey START begins the compliance measurement. Now the values for the crest factor for the voltage (U_{CF}), the RMS voltage (U_{RMS}) and the frequency (FPLL) are recorded. In addition, the power (P) and the RMS current (I_{RMS}) are displayed. If the measured values exceed the specification (see Fig. 6.18), they are shown in yellow. Below the measured values, the results for the "Voltage Waveform" and "Harmonics Current" are shown as OK (measured

values within the specification) or NOT OK (measured values exceed the specification). Pressing the softkey HARMONICS CURRENT also displays the currents of the harmonics in a table. This displays the average values of the current (I_{AVG}), the latest current measured (I_{NOW}) and the maximum currents (I_{MAX}) together with the applicable limits. The LIM values apply to I_{AVG} , the LIM2 values to I_{NOW} or I_{MAX} . You can scroll through the list of values using the rotary control knob. Please see the standard for the

Test Report							
ID: 240002							
EN 50564:2011							
Customer				Test Lab			
Device Under Test				Instrument of Measure			
Consumption				Manufacturer: ROHDE & SCHWARZ			
Pattern: Variable				Device Type: Power Analyzer			
Cycle: 0 s				Model: HMC 8015			
				Serial Number: 012345678			
				Firmware Version: 01.300			
				Calibration Date: 2000-01-01			
				Voltage Range: 300 V			
				Current Range: 0.100 A			
				Current CF Range: 3			
Test Summary				Test Conditions			
Avg. Mains Voltage: 228.58 V				Date: 2016-02-19			
Avg. Mains Freq.: 50.02 Hz				Time: 11:43:40			
Test Method: Sampling Method				Duration: 10 s			
Avg. Power: 6.6533 W				Mains Region: Europe			
Result: FAIL (ABORTED)				Mains Voltage: 230 V			
				Mains Frequency: 50.0 Hz			
				Temperature:			
				Humidity:			
Notes				Test Officer			
				Full Name:			
				Signature: _____			
Page 2 of 2							
Detailed Results							
	Average	Min	Limit Min	Max	Limit Max	Result	
Mains Voltage RMS:	228.58 V	225.36 V	227.70 V	229.02 V	232.30 V	FAIL	
Mains Frequency:	50.02 Hz	50.01 Hz	49.50 Hz	50.03 Hz	50.50 Hz	PASS	
Mains Voltage CF:	1.376	1.373	1.340	1.397	1.490	PASS	
Mains Voltage THD:	2.62 %	2.53 %	N/A	2.77 %	2.00 %	FAIL	
Real Power:	6.653 W	6.356 W	N/A	6.796 W	N/A	N/A	
Apparent Power:	10.655 W	10.209 W	N/A	10.850 W	N/A	N/A	
Power Factor:	0.625	N/A	N/A	N/A	N/A	N/A	

Fig. 6.18: Example of EN 50564 test report

Harmonic Currents [mA]						Restart
#	I _{Avg}	Lim	I _{Now}	I _{Max}	Lim2	Harmonic Currents
2	0.10	1080.00	0.10	0.16	1620.00	
3	21.23	2300.00	21.23	21.55	3450.00	
4	0.15	430.00	0.14	0.25	645.00	
5	13.38	1140.00	13.40	13.60	1710.00	
6	0.18	300.00	0.18	0.32	450.00	
7	13.09	770.00	13.06	13.29	1155.00	
8	0.17	230.00	0.16	0.27	345.00	

Info: Elapsed: 00:03:00 (00:03:00)
 Measurement finished
 UCF out of spec.
 Voltage harmonics out of spec.

Proceed

Fig. 6.20: IEC 61000-3-2 Harmonic Currents

required limits. After the measurement completes automatically (or after it is canceled using the softkey ABORT), the measured values can be saved to a connected USB flash drive in HTML format using the softkeys PROCEED and SAVE HTML.

If a test report has been saved in HTML format to a USB flash drive and the file has been opened using a web browser on the PC, JavaScript must be enabled or the measured values will not display.

The compliance measurement is completed using the softkey FINISH. The measurement can be started again using RESTART. Pressing the key VIEW and then selecting display mode NUMERIC closes Compliance mode and returns to the default display mode.

6.3.3 Test Report

Fig. 6.18 shows a test report example. If the test report is opened using a web browser, specific panes of the report can be edited manually (such as the CUSTOMER, DEVICE UNDER TEST and TEST LAB areas) using the EDIT key. The panes that can be edited are then shown in yellow. Comments can be entered in the NOTES pane. There is also the option of having the CUSTOMER, DEVICE UNDER TEST and TEST LAB fields filled out automatically. In this case, the text files named customer.txt, lab.txt and dut.txt must exist before saving the measured data to the USB flash drive. You can add any labeling you want in these text files. The labeling you provided is then automatically entered into the following test reports.

Customer	Test Lab	Name
Test12345	Rohde&Schwarz	ID240004.HTM
Device Under Test	Instrument of Measure	
Testobjekt	Manufacturer: ROHDE & SCHWARZ	Dut.txt
		Lab.txt
		Customer.txt

Fig. 6.21: Test report example files on USB stick

6.4 Crest Factor

The crest factor (also known as peak factor) describes the factor by which a signal's amplitude (peak value) is greater than the rms-calculated effective value. This is important for the measurement of pulse-shaped sizes. For pure sinusoidal wave types, the following ratio applies: $\sqrt{2}=1.414$.

The accuracy of the calculated effective value remains the same as long as the peak value stays within the peak range. A crest factor of 1.8 or higher indicates a strong distortion from the waveform. To evaluate the waveform distortion of non-linear electric loads, the Waveform or TRENDCHART mode can be used.

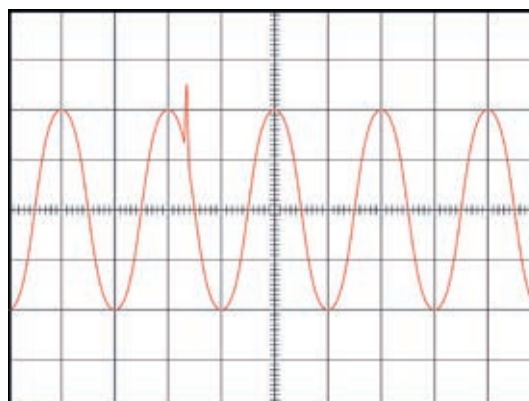

Fig. 6.22: Sample configuration for crest factor 6.

From the ACQ menu, the crest factor can be varied between 3 and 6 by using the softkey CREST FACT in the VOLTAGE or the CURRENT softkey menu. When changing the crest factor, the measuring range is adjusted automatically. A crest factor of 5 or higher is used e.g. for sinusoidal waveforms with spikes (see example in Fig. 6.22) and is also required for standby measurements according to IEC 62018.

6.5 Energy Counter (Integrator Values)

5 V 2 A DC		50:04.0 Log TMC
TIME	50:04.0	U _{AVG} 3.3002 V
P	6.598 W	I _{AVG} 1.9990 A
WH	4.7006 Wh	AH 1.4271 Ah
WHP	5.1030 Wh	AHP 1.5461 Ah
WHM	-0.4024 Wh	AHM -0.1190 Ah

Fig. 6.23: Readout display with integrator output values.

The power analyzer makes it possible to display integrator values (WHP, WHM, AHP, AHM) on the screen. These values are also activated via the measuring parameter cell. In this way, the energy use of electronic devices under test (DUT) can be recorded where power consumption is not constant. WHP / AHP represent the power / current in the positive direction and WHM / AHM in the negative direction. WH / AH correspond to the sum of the watt-hour/ampere-hour positive and negative portions, respectively.

Example:

If a battery is charged with 4 AH and discharged with 3 AH, the display will show AHP = 4, AH- = -3 and the total AH = 1 (i.e. 4 + (-3) = 1).

The Integrator menu can be opened by pressing the softkey INTEGRATOR in the MEAS menu. The relevant integrator mode is then selected using the softkey MODE and the rotary control knob.

6.5.1 Manual Integrator Mode (Default)

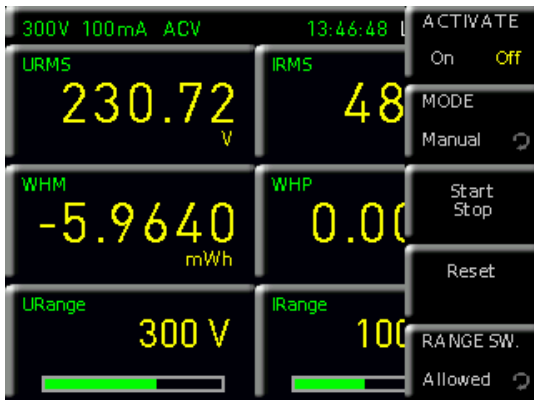

Fig. 6.24: MANUAL integrator menu.

The manual integrator mode is pre-selected by default. Using the START/STOP softkey, or directly using the START/STOP button on the front panel of the instrument, the energy counter can be started as soon as it has been activated (ON) using the ACTIVATE softkey. Pressing either the softkey START/STOP or the START/STOP button on the front panel once more will stop the energy counter. The softkey RANGE SW (Range Switch) is used to define whether the measuring range can be switched during Integrator mode (function ALLOWED) or not (function BLOCKED). The RESET softkey or the RESET button on the front panel will reset the integrator values.

6.5.2 Span Integrator Mode

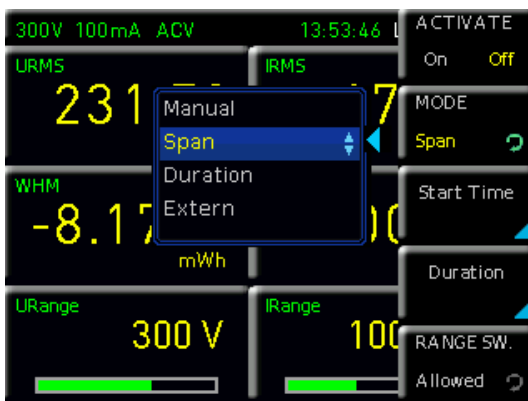

Fig. 6.25: Span integration mode selection menu.

A start time (START TIME) and an integration time span (DURATION) can be set using the SPAN integrator mode. Once the energy counter has been activated (ON) via the ACTIVATE softkey, the counter will automatically start at the preset start time and then automatically stop after the integration time span (DURATION) has elapsed. The time span for the integration can be set using the rotary control knob or, by using the SET TO CURR. softkey, the current system time can be applied and adjusted accordingly. Initi-

ating the start separately by using the START/STOP button on the front panel is not required. The RESET button on the front panel will reset the integrator values.

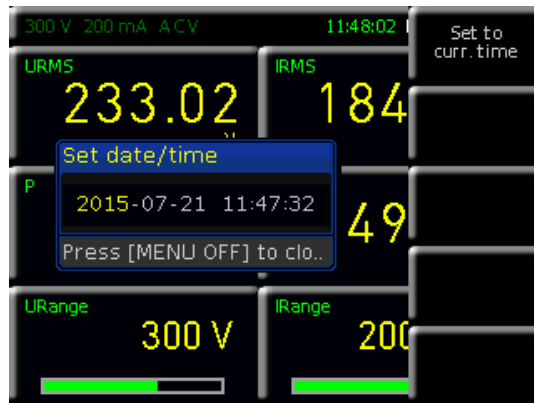

Fig. 6.26: Setting the integration duration.

The maximum duration for running the energy counter is 96 hours (DURATION).

6.5.3 Duration Integrator Mode

The DURATION integrator mode defines how long the energy counter is active. Using the START softkey, or directly using the START/STOP button on the front panel of the instrument, the energy counter can be started as soon as it has been activated (ON) using the ACTIVATE softkey. After the integration time (DURATION) has elapsed, the energy counter is automatically stopped. The time display in the status bar is replaced with the integration time. The time span for the integration can be set using the rotary control knob or, by using the SET TO CURR. softkey, the current system time can be applied and adjusted accordingly. If the integration time is expired, a new integrator measurement can only be started via START button, if the integrator values were reset with RESET softkey. The softkey RANGE SW (Range Switch) is used to define whether the measuring range can be switched during Integrator mode (function ALLOWED) or not (function BLOCKED).

6.5.4 External Integrator Mode (only with HOC152 option / HVC152 voucher)

Using the external integrator mode (EXTERN), the energy counter can be started and stopped by an external pulse at the digital inputs on the rear panel. Once activated (ON) using the ACTIVATE softkey, the energy counter is automatically started by a "high" signal and automatically stopped by a "low" signal. Initiating the start / stop separately by using the START/STOP button on the front panel is not required. The softkey RANGE SW (Range Switch) is used to define whether the measuring range can be switched during Integrator mode (function ALLOWED) or not (function BLOCKED).

6.6 Invert Function

The power analyzer also records the sign of the measured current with AC, for the correct calculation of the exact input or output of power and energy, for example. Depending on the external wiring (e.g. with the HZC815

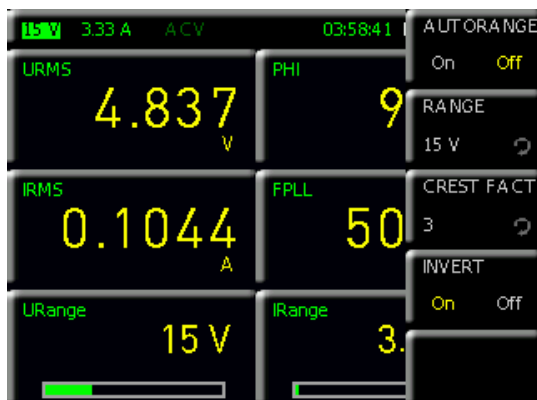

Fig. 6.27: Inversion.

adapter) the voltage or the current is measured inverted. For current-based measurements, the wires going to the jacks A and COM on the front panel must be swapped (see Section 4.2.3). When using the HZC815 measuring adapter, the blue cable must therefore be inserted into the black COM jack, and the black cable is inserted into the blue A jack. In order to record and display the current correctly with this type of wiring, the current direction must be inverted in the ACQ menu using the CURRENT softkey menu and the INVERT softkey. When the INVERT function is activated, it is displayed as a green box around the measuring range displayed in the status bar.

6.7 Acquisition Mode

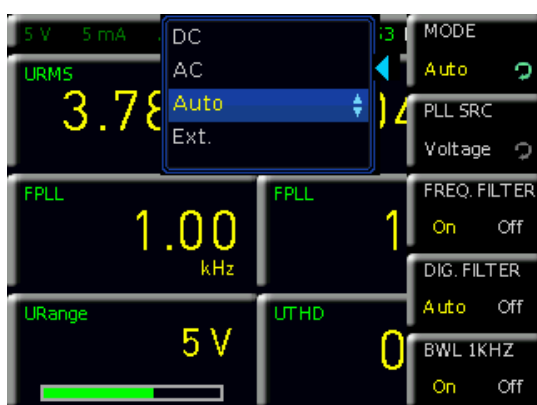

Fig. 6.28: Selecting the data acquisition mode.

The acquisition of current and voltage is performed simultaneously and so can be compared with a two-channel oscilloscope (16 bit). The sampling frequency is 500ksample/s. The values displayed on the screen are updated 10 times per second. In the ACQ menu, the data acquisition mode can be selected by using the MODE softkey menu, followed by the MODE softkey. The following settings can be selected:

- **AUTO:** Automatic selection of the data acquisition mode (default); automatic detection of an incoming signal.
- **DC:** For measuring pure DC loads; in contrast to the AC mode, there is no synchronization with the signal period, instead synchronization is over a certain period of time (error is displayed if AC signal is applied).
- **AC:** Average value of a voltage / current period (synchronization with the signal period).

- **EXTERN:** Specifying a signal period via the external BNC connector DIGITAL IN (only available in conjunction with option HOC152 / upgrade voucher HVC152); e.g. used with a fuzzy signal which must be filtered externally.

6.7.1 Frequency Filter

The power analyzer R&S®HMC8015 features the following filter settings which can be adjusted in the ACQ menu using the softkey menu MODE (for AUTO and AC only):

■ Frequency filter:

Reliable acquisition of the zero crossings for the precise determination of the signal period.

■ Digital filter:

Automatic, adaptive averaging of the filter setting for several periods to increase accuracy; ideal for highly fluctuating values (values become more stable).

■ BWL:

Classic low-pass filter (1 kHz) as bandwidth limit (BWL), in order to produce a clean, HF-adjusted signal.

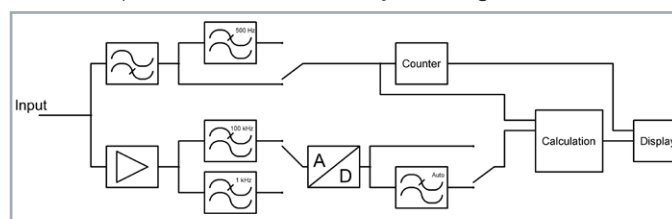

Fig. 6.29: Filters arranged as a chain.

6.7.2 Frequency Source

Use the phase locked loop source frequency synchronization (PLL SRC) softkey, which is only available in Acquisition mode AC, to set the reference variable for the fundamental frequency (VOLTAGE/CURRENT). The fundamental frequency of each period is the reference for the measured harmonics of the reading. Voltage (VOLTAGE) is selected as the reference variable by default. The CURRENT setting makes sense for signals with a very small or an irregular current trace.

6.8 Peak Hold

(only with HOC151 option / HVC151 voucher)

The PEAK HOLD displays maximum peak values, ensuring a stable readout display for loads. The sampling frequency is 500ksample/s. The PEAK HOLD function is activated (ON) or deactivated (OFF) in the ACQ menu by selecting softkey menu PEAK HOLD and softkey ACTIVATE.

If "OL" (Overload) appears on the display, the peak values must be reset on the display using softkey RESET

6.9 Refresh Function

The Refresh function determines how often the display is updated. If the FAST function (yellow) is selected using the REFRESH softkey, the measured values displayed in Numeric mode correspond to the values currently measured. If, on the other hand, the SLOW function (yellow) is selected, the refresh rate of the display is reduced to 1 measured value per second. This measured value corresponds to the average value of the last 10 measurements.

This setting has no effect on the internal acquisition of measured values itself.

6.10 Limits
(only with HOC152 option / HVC152 voucher)

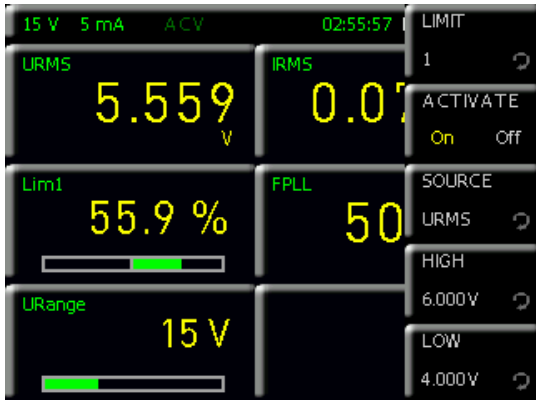

Fig. 6.30: LIMIT menu.

In the MEAS menu, the softkey menu LIMIT can be used to define up to six limit values. Once up to six limit values (LIM1 to LIM6) are selected in the cell configuration, they can be activated (ON) or deactivated (OFF) using the softkey ACTIVATE. The softkey SOURCE and the rotary control knob can be used to select the measurement function for the source. Table 6.4 shows the possible measurement functions. The softkeys HIGH and LOW are used to define maximum and minimum limit values. Similar to the measuring range modulation, a bar is used to display the limit values. This two-part bar indicates the modulation of the limit from -100 % (minimum modulation) to +100 % (maximum modulation). It is also possible to link the limit function with the ANALOG OUT or DIGITAL OUT (EXT menu). See Section 6.11.

Function	Description
P	Active power (W)
S	Apparent power (VA)
Q	Reactive power (var)
LAMBDA	Power factor lambda (λ)
PHI	Phase shift (φ)
FU	Frequency value for the voltage (Hz)
FI	Frequency value for the current (Hz)
FPLL	Frequency and phase locked loop recording frequency (Hz)
URMS	True root mean square (RMS) voltage (U _{RMS})
UAVG	Average voltage
IRMS	True root mean square (RMS) current (I _{RMS})
Iavg	Average current
UTHD	Total harmonic distortion U
ITHD	Total harmonic distortion I

Table 6.4: Overview of LIMIT measurement functions

If the measuring instrument displays only dashes "-----" on the display, either the limit function is not activated or an error occurred (e.g. limit value LOW ≥ limit value HIGH).

6.11 Analog / Digital Inputs and Outputs
(only with HOC152 option / HVC152 voucher)

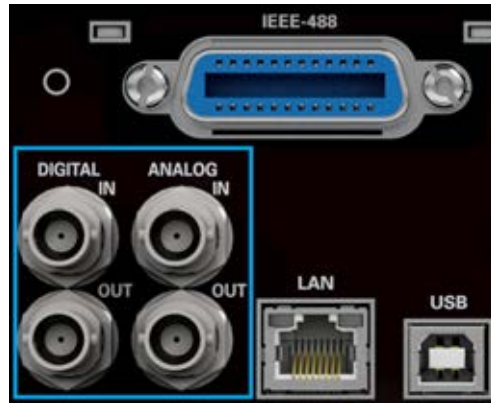

Fig. 6.31: BNC connectors Digital / Analog IN/OUT.

On the R&S®HMC8015 rear panel, there are four BNC connectors that can be used as analog or digital inputs and outputs (Digital / Analog IN/OUT). The connectors are available for limit values and Pass/Fail sorting, for example.

6.11.1 Analog IN

The ANALOG IN can be activated (ON) or deactivated (OFF) in the EXT menu by selecting softkey menu ANALOG IN and softkey ACTIVATE. In addition, the AIN function in the cell configuration can be used to display the measured value of the analog input signal on the screen.

6.11.2 Analog OUT

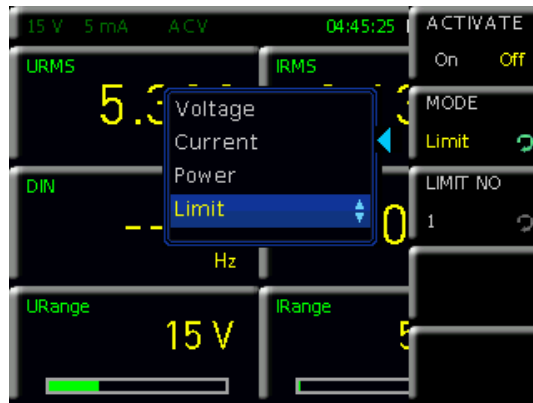

Fig. 6.32: ANALOG OUT menu.

The ANALOG OUT can be activated (ON) or deactivated (OFF) in the EXT menu by selecting softkey menu ANALOG OUT and softkey ACTIVATE. The minimum voltage modulation of the output is -5V, the maximum voltage modulation is +5V. The external mode is selected by using softkey MODE and the rotary control knob. The following modes can be selected:

Voltage:

Minimum modulation at the output corresponds to 0 V and maximum modulation corresponds to the measuring range.

Current:

Minimum modulation at the output corresponds to 0 V and maximum modulation corresponds to the measuring range.

Power:

Minimum modulation at the output corresponds to 0 W and maximum modulation corresponds to the maximum current and voltage measuring ranges.

Limit:

The limit module is connected to the analog output. The output modulation is represented as a percentage %. -100 % corresponds to minimum modulation at the output ($\triangleq -5$ V) and +100 % corresponds to maximum modulation ($\triangleq +5$ V). The limit value (LIM1 to LIM6) is selected using softkey LIMIT NO and the rotary control knob.

Example:

A 230 V DUT (for example, a desk lamp) is connected. A crest factor of 3 and a measuring range of 300 V have been selected, that is, the maximum measuring range is $300\text{ V} * 3 = 900\text{ V}$. The 230 V of the DUT referenced to the maximum measuring a range of 900 V and the maximum deflection of the ANALOG OUT of +5 V yields: $(230\text{ V} / 900\text{ V}) * 5\text{ V} = 1.278\text{ V}$. If an oscilloscope is now connected to ANALOG OUT on the back panel of the device and ANALOG OUT is activated by way of the EXT menu, the oscilloscope shows a sine curve on the screen with 1.278 VRMS or 3.6 Vpp (see Fig. 6.33).

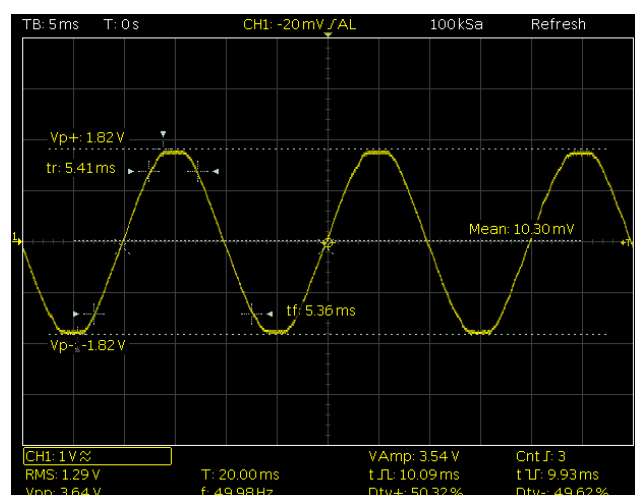

Fig. 6.33: Analog Out example

6.11.3 Digital IN

The DIGITAL IN can be activated (ON) or deactivated (OFF) in the EXT menu by selecting softkey menu DIGITAL IN and softkey ACTIVATE. In addition, the DIN function in the cell configuration can be used to display the measured value of the digital input signal on the screen. The different modes can be selected using softkey MODE and the rotary control knob:

Frequency:

The power analyzer measures the frequency at the DIGITAL IN.

PWM:

The power analyzer measures the relationship between High and Low.

State:

The power analyzer measures the High and Low levels.



Fig. 6.34: DIGITAL IN menu.

The softkey INVERT is used to invert the signal applied at DIGITAL IN. This makes sense in STATE mode, for example.

6.11.4 Digital OUT

The DIGITAL OUT can be activated (ON) or deactivated (OFF) in the EXT menu by selecting softkey menu DIGITAL OUT and softkey ACTIVATE. The external mode is selected by using softkey MODE and the rotary control knob. The following modes can be selected:

Limit:

The limit module is connected to the digital output. The High level at the output corresponds to logical True and the Low level corresponds to False.

FPLL:

The output is controlled by an FPGA and always outputs the frequency of the selected source.

7 Data Logging

Using the MEAS button and the LOGGING softkey menu, the data acquisition can be started and various settings can be selected. Using the ACTIVATE softkey, data acquisition and storage can be activated (ON) or deactivated (OFF). Using the STORAGE softkey menu, the type of storage device can be selected (Internal / USB flash drive), as well as the file name (File Name) and the file format (CSV / TXT). Using the LOG PAGE softkey, the active measuring parameter cells menu (Quick Menu 1 to 4 on the main screen) can be selected. If LOG PAGE 1 is selected, only the readings from the first measuring parameter cell menu (Quick Menu 1 on the main screen) are recorded. If LOG PAGE 2 is selected, only the readings from the second measuring parameter cell menu (Quick Menu 2 on the main screen) are recorded, and so on. Using the INTERVAL softkey and the rotary control knob, a measuring interval can be set. The measuring interval is the time between readings. If, for example, the INTERVAL function is set to 5, then a reading is taken every 5 s. The MODE softkey menu offers various logging modes. Select the UNLIMITED function if you intend to make an infinitely long data record. The limiting factor here is the size of the internal memory (512 kbyte max.) or that of the connected USB flash drive (4 Gbyte max., FAT/FAT32 formatting). If the COUNT function is active, the number of recorded events can be set with the COUNT softkey and the rotary control knob. If, for example, an interval of 5 s and a count of 5 are set, then 5 readings will be recorded at intervals of 5 s. If the DURATION function is activated, the recording duration for the readings can be adjusted with the DURATION softkey and the rotary control knob. If the SPAN function is activated, a logging time span can be defined. Use the softkey menu START to define when the logging function should start. Using the DURATION softkey menu, the recording duration for the readings is defined.

External USB hard drives (or USB extensions) are not supported. Only USB flash drives with FAT/FAT32 formatting (4 Gbyte max.) are recognized by the R&S®HMC8015.

	A	B	C	D	E	F	G
1	URMS[V]	IRMS[A]	P[W]	WH[Wh]	FPLL[Hz]	LAMBDA[λ]	Timestamp
2	230,80	0,05	6,63	0,109	50,00	0,545	00:01:49:000
3	230,72	0,05	6,63	0,111	50,00	0,545	00:01:50:000
4	230,66	0,05	6,63	0,113	50,00	0,545	00:01:51:000
5	230,77	0,05	6,63	0,114	50,00	0,543	00:01:52:000
6	230,77	0,05	6,63	0,116	50,00	0,545	00:01:53:000
7	230,69	0,05	6,63	0,118	50,00	0,545	00:01:54:000
8	230,75	0,05	6,64	0,120	50,00	0,546	00:01:55:000
9	230,91	0,05	6,62	0,122	50,00	0,544	00:01:56:000
10	230,88	0,05	6,63	0,124	50,00	0,542	00:01:57:000
11	230,94	0,05	6,63	0,126	50,00	0,544	00:01:58:000
12	230,97	0,05	6,63	0,127	50,00	0,543	00:01:59:000
13	230,83	0,05	6,63	0,129	50,00	0,544	00:02:00:000
14	231,02	0,05	6,63	0,131	50,00	0,544	00:02:01:000
15	230,97	0,05	6,63	0,133	50,00	0,546	00:02:02:000
16	230,86	0,05	6,62	0,135	50,00	0,546	00:02:03:000
17	230,64	0,05	6,63	0,137	50,00	0,545	00:02:04:000
18	230,72	0,05	6,63	0,138	50,00	0,547	00:02:05:000
19	230,77	0,05	6,62	0,140	50,00	0,546	00:02:06:000
20	230,75	0,05	6,63	0,142	50,00	0,546	00:02:07:000

Fig. 7.1: Graphical log file analysis in Excel.

The maximum logging duration is 96 hours (DURATION).

Using the SPAN function, a start time (START TIME) and a logging time span (DURATION) can be set. Once the logging function has been activated (ON) via the ACTIVATE softkey, the data acquisition will automatically start at the preset start time and then automatically stop after the logging time span (DURATION) has elapsed. The time span for the logging can be set using the rotary control knob or, by using the SET TO CURR. TIME softkey, the current system time can be applied and adjusted accordingly.

The log function is active if the color of the LOG display in the status bar has changed to green, or inactive if it is white.

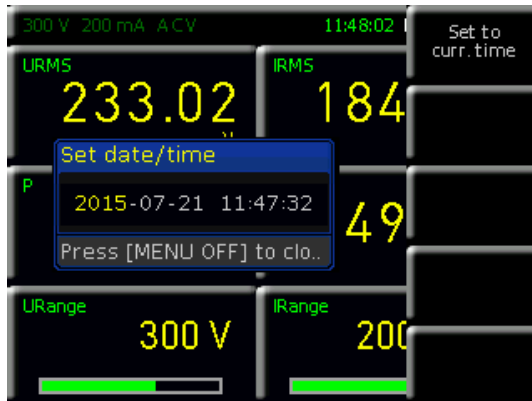
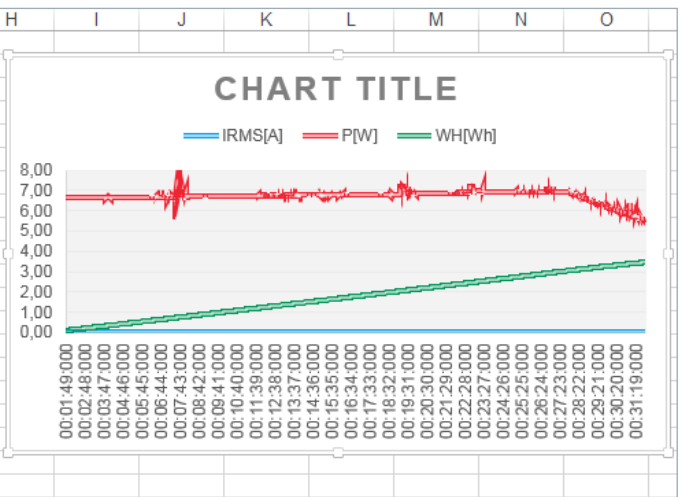

Fig. 7.2: Setting the integration duration.

Using the CSV softkey menu, the structure of the CSV file can be configured. This is used to define the decimal separator (DEC.SEP.) as well as the line separator (FIELD DELIM.). Data saved in a CSV file can be opened with Microsoft Excel, for example, and displayed as graphical charts (see example in Fig. 7.1). There is also the option of changing the composition of a CSV file using the ERROR VAL softkey (see Section 9.3.7).

Gaps in the logging may occur under the following circumstances:

- High load caused by SCPI commands over the interface
- Use of a "slow" USB flash drive
- Sector in file system is sized too large



7.1 Example of Data Format in a Log File

```
#Device;HMC8015
#Device Name;PM
#Format;LOG
#Date;2000-01-01
#Version;00.021-02.430-03.730
#Serial No.;012345678
#Mode;Count
#Logging Interval[s];1.000
#Specified Logging Count;1800
#Specified Logging Time[s];-----
#Start Time;04:49:33
#Stop Time;04:49:37
#Actual Count;4
```

```
URMS[V];IRMS[A];P[W];FU[Hz];EMPTY;EMPTY;S[VA];Q[var]
;LAMBDA[];UTHD[%];Timestamp
231.27E+00;45.0E-03;6.63E+00;50.0E+00;nan;nan;10.38E+
00;7.98E+00;639E-03;2E+00;04:49:33:000
231.38E+00;45.0E-03;6.64E+00;50.0E+00;nan;nan;10.38E
+00;7.98E+00;639E-03;2E+00;04:49:34:000
231.35E+00;45.0E-03;6.63E+00;50.0E+00;nan;nan;10.38E
+00;7.98E+00;639E-03;2E+00;04:49:35:000
231.38E+00;44.9E-03;6.63E+00;50.0E+00;nan;nan;10.38E
+00;7.99E+00;639E-03;2E+00;04:49:36:000
```

If the CSV file contains "nan" (= not a number), then either the corresponding measuring parameter cell was empty (EMPTY), or the reading could not be displayed due to the chosen settings (see section 9.3.7).

7.2 Data Formatting in Excel/Import Wizard

If a CSV log file is opened with Excel, the measurement data is displayed correctly. However, we recommend that you change the formatting of the time stamp (Timestamp) manually. After opening the CSV file, the formatting of

the time stamp can be adjusted by first selecting the time stamp values and then clicking the right mouse button for "Format Cells". Then, using the "User Defined" function, the formatting can be configured manually with the keyboard in the "type" section as follows (see Fig. 7.4):

hh:mm:ss,000

After confirming with the OK button, the user-defined custom formatting is saved, and the time stamp values are displayed in the selected format. By doing this, even the smallest millisecond values can be read easily.

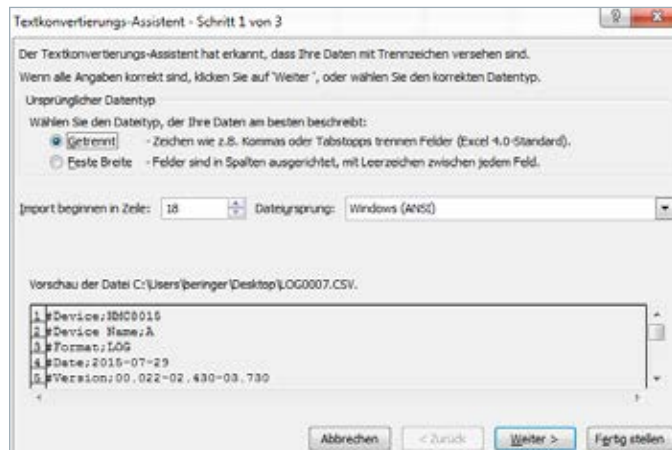

Fig. 7.4: Excel Import Wizard (Text Import Wizard).

It is also possible to use the Import Wizard in Excel. After starting Excel, first select the relevant CSV file by clicking on the tab "Data" → "From Text". After selecting the file and confirming with the "Import" button, the Import Wizard is started. This Text Import Wizard can also be used to format the CSV file as needed. For example, the "Start import on line" function can be configured in a way that only the readings are imported without the header (e.g. 18, see Fig. 7.4).

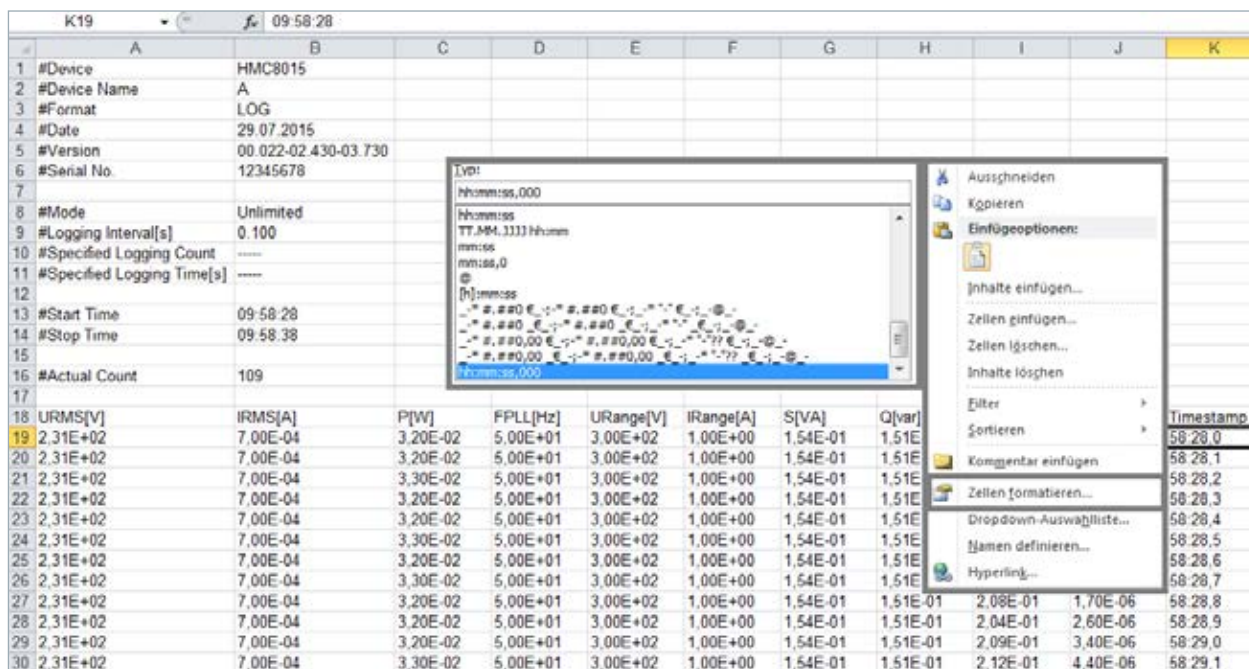

Fig. 7.3: User-defined customization of time stamp formatting in Excel.

8 Documenting, Saving and Retrieving

The R&S®HMC8015 power analyzer allows the user to save all screen displays and user settings. Internal memory is used to store device settings. This type of data can also be saved to any USB flash drive connected to the unit. However, screen captures can only be saved to a USB flash drive. The main menu for the saving and recalling/uploading of functions is opened by pressing the SAVE/RECALL button.

8.1 Device Settings

Using the DEVICE SETTINGS softkey menu, the currently active device settings can be saved, and previously saved settings can be retrieved/uploaded.

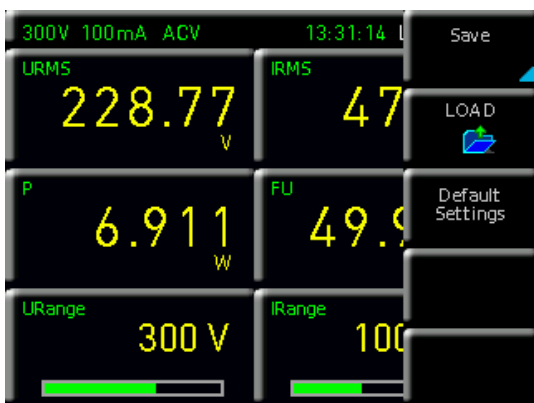

Fig. 8.1: Saving / Loading device settings

Pressing the SAVE softkey will open the Save to Memory menu. Using the STORAGE softkey, a possible location (INTERNAL or FRONT) is selected for the device settings to be stored. After selecting the desired storage location and pressing the ACCEPT softkey, the File System Manager is opened. The file name (FILE NAME) can be adjusted to the currently active setting or changed entirely (the default name is SET). Use the COMMENT softkey to add a comment that will appear in the footer of the File Manager if the file has been selected. Device settings are stored in HDS format (binary). The format cannot be changed. The settings are saved using the SAVE command.

Device settings from an old firmware version cannot be loaded with a new firmware version.

To upload files containing saved settings, the LOAD softkey menu is opened by pressing the corresponding softkey. This will open the File Manager, in which the desired file can be selected using the rotary control knob. Once the storage location and the settings file are selected, the

file is uploaded by pressing the LOAD softkey. To remove settings files that are no longer needed, the corresponding file is selected with the rotary control knob and removed using the REMOVE FILE softkey. When a USB flash drive is connected, directories can be changed or deleted as well. The menu item DEFAULT SETTINGS provides the ability to upload and return to the factory default settings.

8.2 Screenshots

The most important method of storing data for documentation purposes is the screenshot. A screenshot is an image file that shows the current screen contents at the moment it is captured to a file. However, screenshots can only be saved to a USB flash drive. When a USB flash drive is connected, directories can also be changed, created or deleted. The choice of the target directory is confirmed with ACCEPT. The name of the file (FILE NAME) can be adjusted to the currently active setting or changed entirely (the default name is SCR).

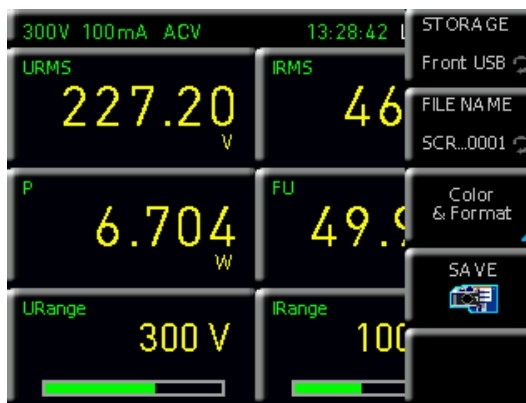

Fig. 8.2: Screenshot settings menu

The selected file format for the graphic file then determines the color depth and the type of compression. There is no difference in the quality of these formats with respect to the instrument graphics. The following file formats can be selected from the softkey menu FORMAT:

- BMP = Windows Bitmap Format
- PNG = Portable Network Graphic

Using the COLOR MODE softkey and the rotary control knob, the user can choose between GRAYSCALE and COLOR. In GRAYSCALE, the colors are converted to grayscale, while saving in COLOR saves the image as displayed on the screen. Pressing the softkey SAVE triggers an immediate saving of the current screen to the preset location and using the preset name and format.

A screenshot will be saved (depending on the menu setting) on a connected USB flash drive by holding down the SAVE/RECALL button.

The Screenshot function of the HME Explorer Software can also be used (the Screenshot software module). The HME Explorer Software, which is free of charge, makes it possible to transfer screenshots in bitmap (BMP) or PNG format via an interface from the device to a connected PC

and to save them or print them out from there. You can find additional information on the software in the HMExplorer Software Manual.

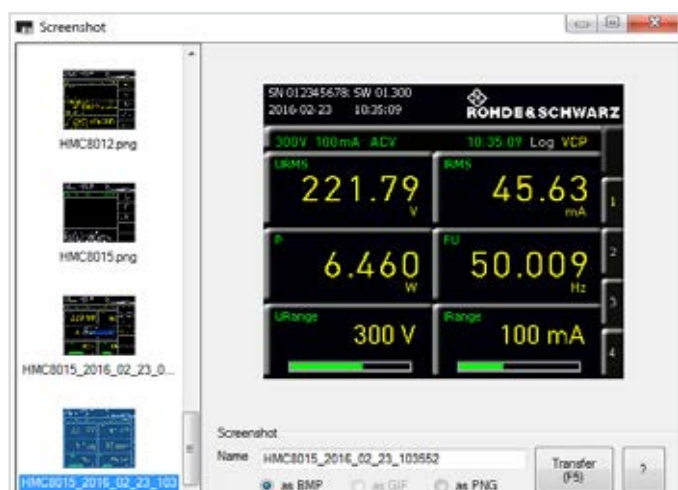

Fig. 8.3: Screenshot module of the HMExplorer Software

9 General Settings

Important basic settings such as general or interface settings can be set using the SETUP button. Use the  button to go back one level.



Fig. 9.1: Setup menu

9.1 Updates (Instrument Firmware)

The firmware is compressed into a ZIP file. When the ZIP file is downloaded, it is decompressed into the root directory of a USB flash drive. Once the USB flash drive is connected to the USB port of the instrument, press the SETUP button. Using the UPDATE softkey, the update menu opens and the currently installed firmware version is displayed together with its version number, date and build information.

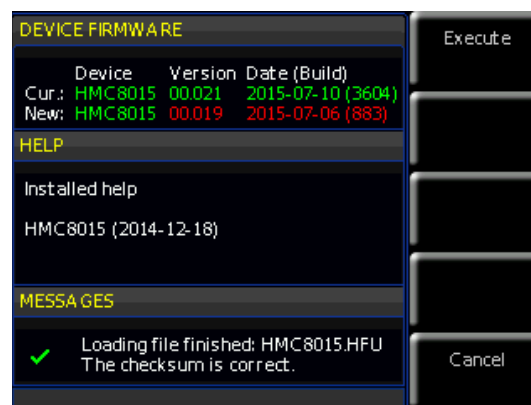

Fig. 9.2: Firmware update menu.

When the FIRMWARE softkey is pressed, a search for the corresponding file is started on the USB flash drive, and all information of the new firmware to be installed from the flash drive is displayed. If the firmware on the device is already identical to the most current version, then the version number from the USB flash drive is displayed in red, otherwise the version number is displayed in green. In the latter case, the update should be started by pressing the EXECUTE softkey.

9.2 Interface Setup

Using the INTERFACE softkey menu, settings for the following can be created:

- **VCP** (virtual COM port)
- **USB TMC**
- **Ethernet** (IP address, subnet mask etc.) and
- **IEEE-488 GPIB** interfaces (GPIB address)

The interface to be used for communications is selected with the corresponding softkey. The necessary interface parameters are configured under the softkey menu item for parameters. See Chapter 10 for more information about the available interfaces.

9.3 General Settings (Misc)

9.3.1 Device Info

Using this softkey, it is possible to access device information, such as serial number, software version etc. In addition, the remaining available internal memory is displayed.

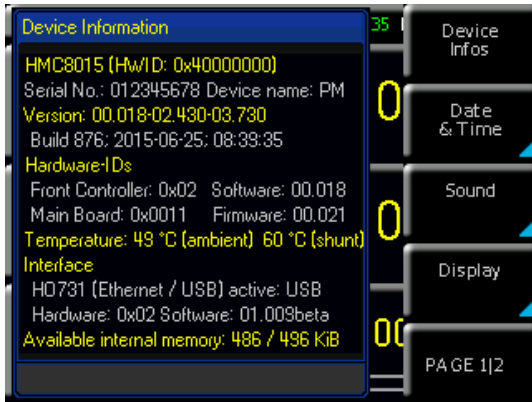

Fig. 9.3: Instrument information.

9.3.2 Date & Time

Using the DATE & TIME softkey, it is possible to set the time of day and the date, which are then used to create a date and time stamp on printer output or in saved data-sets. The date and time can always be reset by the user. The settings for date and time may be configured using the rotary control knob. The corresponding softkey menu item is active if it is highlighted in yellow. The date or time parameters can be transferred by using the SAVE command.

9.3.3 Sound

The power analyzer provides the option for issuing a signal in the event of failure (or even as a test). This option can be activated (ON) or deactivated (OFF) using the ERROR BEEP or CTRL BEEP softkeys. The corresponding softkey menu item is active if it is highlighted in yellow.

9.3.4 Display

Using the DISPLAY softkey menu and the BACKLIGHT softkey, the screen intensity (i.e. brightness and contrast) can be varied between 10 % to 100 % using the rotary control knob. Using the CONTRAST and BRIGHTNESS

softkeys, screen contrast and brightness can each be set between 10 % and 100 %. The GRID INTENS. softkey is used to set the intensity of the display grid for graphical displays. This menu item is only available in conjunction with the HOC151 option or the HVC151 upgrade voucher. The corresponding softkey menu item is active if it is highlighted in yellow.

9.3.5 Key Brightness (KEY)

With the KEY BRIGHT softkey, the button brightness can be varied from 10 % to 100 % using the rotary control knob. You can use the FALLBACK softkey to set the key fallback time to 5 s, 10 s or 20 s. Once the fallback time is set, the settings window will be closed automatically after the set time. In addition, the automatic return to the previous level can also be deactivated (OFF). The corresponding softkey menu item is active if it is highlighted in yellow.

9.3.6 Device Name



Fig. 9.4: Entering the instrument name.

The device name can be edited in this menu. A keypad is opened by pressing the DEVICE NAME softkey. Characters can be selected using the rotary control knob. The respective character is then confirmed by using the ENTER button (SHIFT). The entered device name is finally confirmed by using the ACCEPT softkey.

9.3.7 CSV

Using the CSV softkey menu, the structure of the CSV file can be configured. This is used to define the decimal separator (DEC.SEP.) as well as the line separator (FIELD DELIM.).

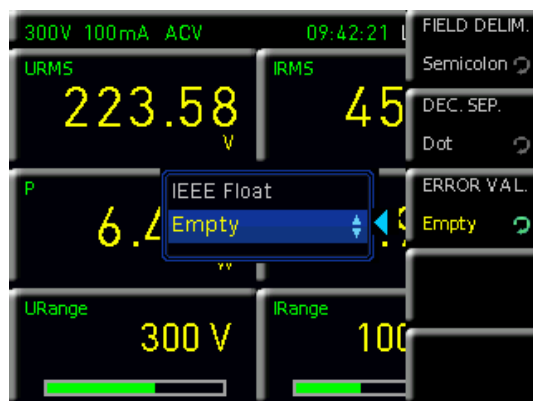

Fig. 9.5: CSV structure

There is also the option of changing the composition of a CSV file using the ERROR VAL softkey. If the CSV file contains "nan" (not a number), then either the corresponding measuring parameter cell was empty (EMPTY) or the measured value could not be displayed due to the chosen settings. This "nan" entry could not be correctly interpreted, for example, by Microsoft Excel. Excel interprets the "nan" column as "0". For this reason, the ERROR VAL function EMPTY is recommended. With this function, the appropriate column is left empty in the CSV file and is interpreted as a gap in a graph analysis. In other high-level languages such as MatLab or Open Office, the "nan" column is interpreted correctly and the ERROR VAL function IEEE FLOAT can be retained as the default setting. Switching to EMPTY is not necessary in this case.

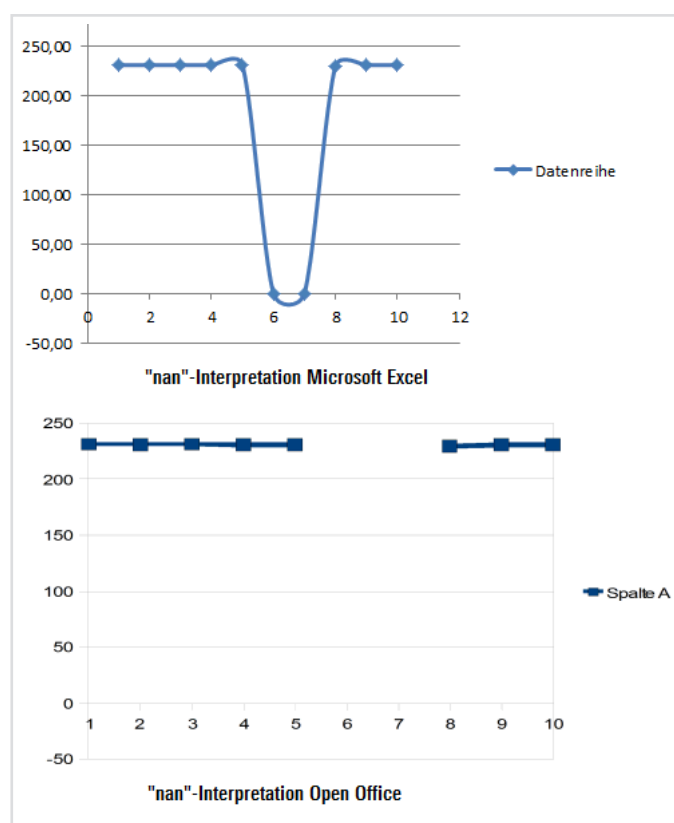

Fig. 9.6: "nan"-Interpretation Excel / Open Office

10 Remote Operation

The R&S®HMC8015 comes with standard Ethernet and USB interfaces.

To enable communications, the selected interface and the associated settings in the device must exactly match those on the PC.

In addition to a LAN interface, the R&S®HMC8015 has a USB device port. For this interface, the user can choose whether the device is to be addressed via a virtual COM port (VCP) or via the USB TMC class. A GPIB interface is available as option from the factory (R&S®HMC8015-G). The GPIB interface has a dedicated slot on the rear panel.



Fig. 10.1: Rear panel.

10.1 USB VCP

The available USB VCP drivers have been fully tested and are available for Windows XP™, VISTA™, Windows 7™, Windows 8™ and Windows 10™ (32 bit and 64 bit).

When using the classic Virtual COM Port (VCP) variant, the user can, after installing the corresponding Windows driver for a terminal program, communicate with the R&S®HMC unit using SCPI commands. The latest USB VCP driver can be downloaded free of charge from the ROHDE & SCHWARZ website <www.rohde-schwarz.com> in the downloads section, and decompressed into an appropriate directory. If a driver for the R&S®HMC compact series has not yet been installed on the computer, the operating system responds with the message "Found New Hardware" once the connection between the device and the PC has been established. In addition, the "Found New Hardware Wizard" is displayed. If this occurs, the

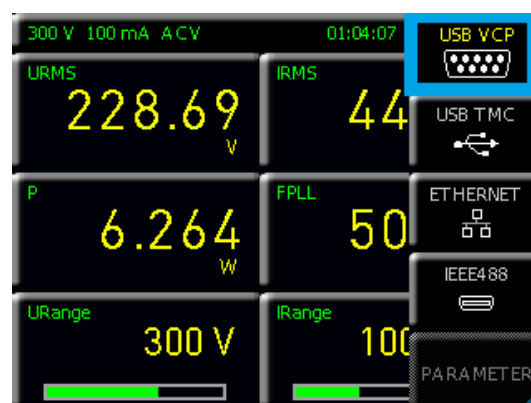

Fig. 10.2: USB VCP settings.

The USB VCP driver can only be installed on a PC if the following prerequisites are met:

1. R&S®HMC8015 with USB VCP interface enabled
2. A PC with the Windows XP™, VISTA™, Windows 7™, Windows 8™ or Windows 10™ (32 bit or 64 bit) operating system
3. Administrator privileges are required for installing the driver. If an error message is displayed citing a write error, this is generally caused by not having the required access credentials for the installation of the driver. In this case, contact your IT department to obtain the necessary privileges.

USB driver must be installed. For more information about USB VCP driver installation, see the installation instructions in the driver file.

In addition, the free HME Explorer software can be used. This Windows application offers the ability to create screenshots for the R&S®HMC8015 in addition to having a terminal program or power module function.

10.2 USB TMC

The modern alternative to a Virtual COM Port (VCP) for external control is using the USB TMC procedure. TMC stands for “Test & Measurement Class” which means that once Virtual Instrument Software Architecture (VISA) drivers have been installed, the connected device can be detected without specialized Windows drivers, and used directly in the corresponding environments. The structure of the TMC procedure is modeled on the GPIB interface. Therefore, the great advantage of the USB TMC is that, by querying special registers, it can be determined whether commands were correctly processed and have been completed. By contrast, when communicating using VCP, testing and polling mechanisms in the control software are needed for this purpose, which may lead to a considerable workload on the device interface. This problem is solved when using the USB TMC by using the TMC status registers, similar to a GPIB interface hardware-based solution through corresponding control lines.

Communications via USB TMC are not supported by the HME Explorer software.

10.2.1 USB TMC Configuration

The R&S®HMC8015 power analyzer assumes a generic USB device driver when it is operated in USB TMC mode. The USB Test & Measurement Class (USB TMC) is a protocol that enables GPIB-like communications using USB interfaces and represents a unique device class within the USB specification. The USB TMC protocol supports service queries, triggers and other GPIB-specific instructions. The driver is included in the NI Virtual Instrument Software Architecture (VISA) package and can be downloaded from <<http://www.ni.com/downloads/ni-drivers/>>.

First, the NI-VISA driver must be installed on your Windows system. To do this, download the latest version of the NI-VISA driver package. Decompress the driver package you just downloaded and follow the installation instructions.

Here is an example for NI-VISA version 5.4.1:

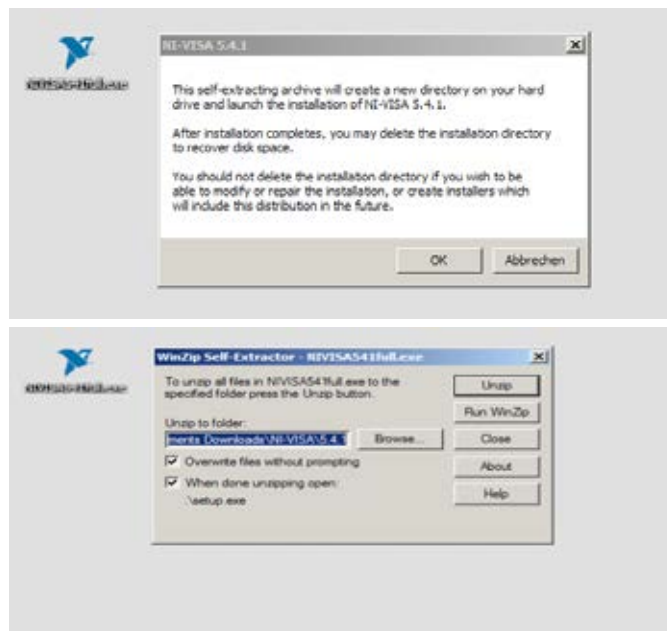

Fig. 10.3: NI-VISA 5.4.1.

Start the installation with “Next” and follow the installation instructions.



Fig. 10.4: NI-VISA installation guide.

For this step, select “NI-VISA xxx → All applications installed locally”.

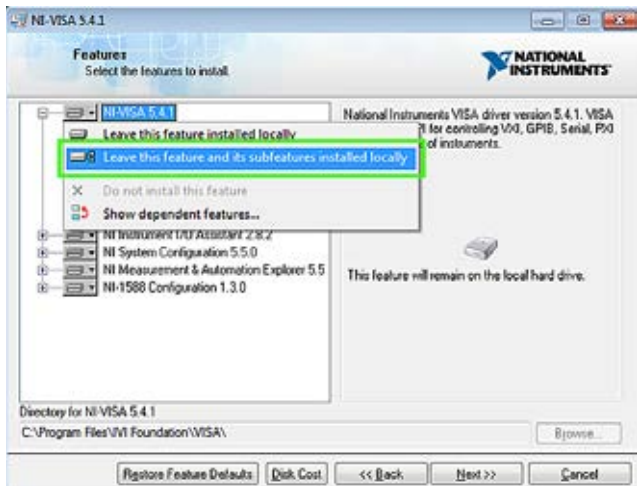

Fig. 10.5: Installing NI-VISA application locally.

After successfully installing the NI-VISA driver, you can now switch your R&S®HMC8015 to the USB TMC interface. To do so, please access the SETUP menu of your R&S®HMC8015 and select "Interface".

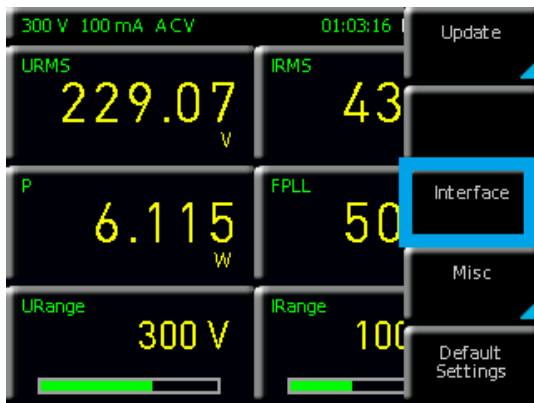

Fig. 10.6: Setup menu.

Then, using the softkey, switch to "USB TMC".

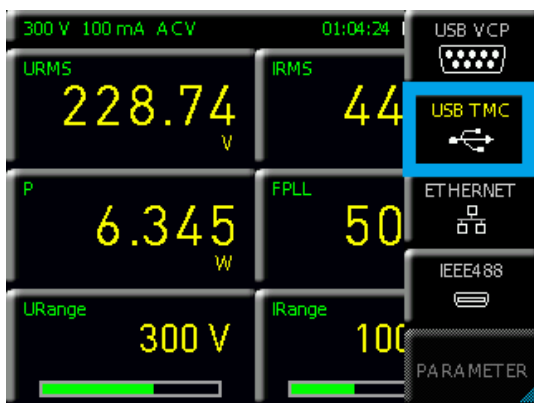

Fig. 10.7: Interface menu.

The top of the screen now shows "TMC" as the selected interface type.

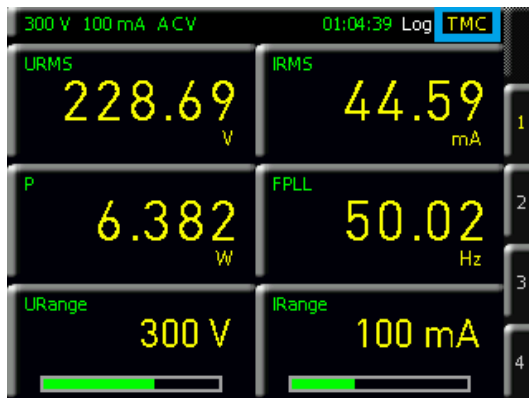

Fig. 10.8: TMC display on the screen.

Finally, establish the connection between the power supply unit and your Windows PC with a USB interface cable (type A – B). When used for the first time, the operating system reports back with the message "Found New Hardware". After successful configuration, the window "Device Driver Installation" appears with the message "USB Test and Measurement Device (IVI), use now enabled".



Fig. 10.9: Device driver installation.

Open the Windows Device Manager. The device is now listed under "USB Test and Measurement Devices > USB Test and Measurement Device (IVI)".

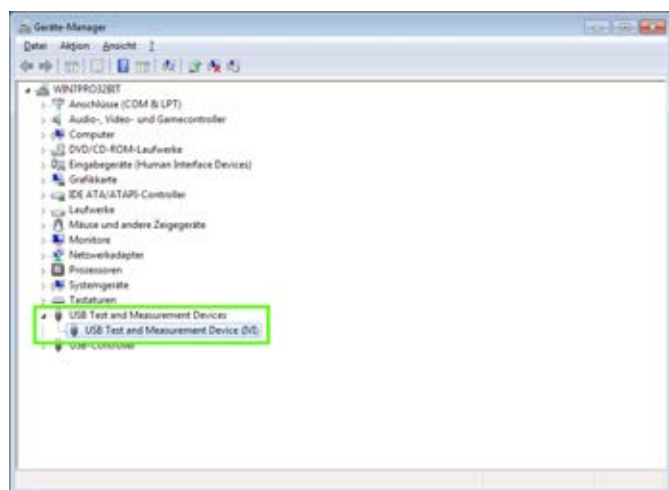

Fig. 10.10: Display in the device manager.

10.3 Ethernet

For direct connection to a host (PC) or indirect connection using a switch, a double-shielded network cable (e.g. CAT.5, CAT.5e, CAT.5+, CAT.6 or CAT.7) is required, with RJ-45 connectors on both ends. Either a straight or a crossover cable may be used for the network cable.

10.3.1 Internet Protocol (IP) Networks

In order for two or more network elements to communicate with each other through a network (e.g. measuring instruments, hosts/PCs, etc.), a number of basic connections must be observed, to facilitate the correct and undisturbed execution of the data transmission in networks. Each network element within a network must be assigned an IP address in order for them to exchange data. IP addresses are represented (in the IP version 4 or IPv4) in the form of four decimal numbers separated by periods (e.g. 192.168.15.1). Each decimal number represents a binary number of 8 bits (or one byte). IP addresses are divided into public and private address ranges. Public IP addresses are routed through the Internet and are provided by an Internet Service Provider (ISP). Network elements which have a public IP address can be reached via the Internet as well as exchange data over the Internet directly. Private IP addresses are not routed through the Internet and are reserved for private networks. Network elements which have a private IP address cannot be reached via the Internet and cannot exchange data over the Internet directly.

In order for network elements with private IP addresses to exchange data over the Internet, a router that performs IP network address translation (NAT) must connect them to the Internet. Using this router, which has a private IP address (the LAN IP address) and a public IP address (the WAN IP address), the network elements are connected to the Internet and can exchange data. In cases where network elements only ever exchange data through a local area network (without connection to the Internet), it is best to use private IP addresses. Choose a private IP address for the device and also a private IP address for the host (PC) used to control the device. If you later connect your private network through a router to the Internet, you can keep the previously used private IP addresses for use on your local

network. As with any IP address range, the first IP address denotes the network and the last IP address is used as a broadcast IP address, therefore these two IP addresses must be subtracted from the “number of possible host addresses” (see Table 10.1: Private IP address ranges). In addition to the classification of IP addresses into public and private address ranges, IP addresses are further divided into classes (Class: A, B, C, D, E). The private IP address ranges described above would fall within categories A, B, and C. The classification of IP addresses is important for the allocation of public IP address ranges, and depends mainly on the size of a local area network (i.e. maximum number of hosts on the network), when it is connecting to the Internet (see Table 10.2: Classes of IP addresses).

IP addresses can be allocated as permanent (static) or variable (dynamic). If permanent IP addresses are assigned in a network, an IP address must be set manually for each network element. If variable IP addresses are automatically (dynamically) assigned to the connected network elements, the task of allocating the IP addresses then requires a Dynamic Host Configuration Protocol (DHCP) server. When using a DHCP server, a range of IP addresses can be preset for the automatic allocation of the IP addresses. DHCP servers are typically already integrated into routers. If however a network element (device) is directly connected via a network cable to a host (PC), no IP addresses can be allocated automatically to the measuring device and the host (PC), because in this case, there is no available network with a DHCP server. They must therefore be specified manually on the device and the host (PC). With the help of subnet masks, IP addresses are broken up into the network portion and the host portion, similar to a phone number being broken up into area prefix (international country code and local area code) and phone number (subscriber number). Subnet masks have the same form as IP addresses. They are represented in the form of four decimal numbers separated by periods (e.g. 255.255.255.0). As with the IP addresses, each decimal number represents a binary number of 8 bits (or one byte). The subnet mask manages the separation of an IP address into the network portion and the host portion (e.g. the IP address 192.168.10.10 is split up by the subnet mask

Address range	IPv4 subnet mask(s)	CIDR notation	Number of available host addresses
10.0.0.0 to 10.255.255.255	255.0.0.0	10.0.0.0/8	$2^{24} - 2 = 16\,777\,214$
172.16.0.0 to 172.31.255.255	255.240.0.0	172.16.0.0/12	$2^{20} - 2 = 1\,048\,574$
192.168.0.0 to 192.168.255.255	255.255.0.0 255.255.255.0	192.168.0.0/16 192.168.0.0/24	$2^{16} - 2 = 65\,534$ $2^8 - 2 = 254$

Table 10.1: Private IP address ranges

Classes	Address range	Network portion	Host portion	Max. number of networks	Max. number of hosts per network
A	0.0.0.1 to 127.255.255.255	8 bit	24 bit	126	16.777.214
B	128.0.0.1 to 191.255.255.255	16 bit	16 bit	16.384	65.534
C	192.0.0.1 to 223.255.255.255	24 bit	8 bit	2.097.151	254
D	224.0.0.1 to 239.255.255.255	Reserved for multicast applications			
E	240.0.0.1 to 255.255.255.255	Reserved for special applications			

Table 10.2: IP address classes

255.255.255.0 into a network part 192.168.10.0 and a host part 0.0.0.10). The allocation is achieved by the conversion of both IP address and subnet mask into binary form, followed by a bitwise logical AND operation between IP address and subnet mask. The result is the network portion of the IP address.

By contrast, the host portion of the IP address is formed by a bitwise logical NAND operation between IP address and subnet mask. By using subnet masks to achieve a variable (dynamic) allocation of IP addresses into network portion and host portion, the user can specify IP address ranges for large as well as small networks individually. This allows the user to operate both large and small IP networks and, if necessary, connect them through a router to the Internet. In smaller local area networks, the subnet mask of 255.255.255.0 is generally used. In this case, the network portion (the first three of the four decimal numbers) and the host part (the last decimal number) can be identified without much mathematical effort, and up to 254 network elements (e.g. measuring devices, hosts/PCs etc.) can be simultaneously operated in such a network when using this subnet mask. Very often, a network will have a default gateway. In most local networks, this gateway is identical to the router used for the Internet (DSL router, ISDN router etc). Using this (gateway) router, a connection can be made to another network. This makes it possible to reach network elements which are not in the same (local area) network, or network elements from the local network can exchange data with network elements from other networks. In order to enable network-wide data exchange, the IP address of the default gateway must also be set. In local networks, the first IP address within a network is generally used for this (gateway) router. Routers which are used as a gateway in a local area network often have an IP address with a "1" as the last digit of the IP address (e.g. 192.168.10.1).

10.3.2 Ethernet Settings

PC and device must be in the same network, otherwise a connection is not possible.

The network interface card comes with a USB interface and an Ethernet interface. The configuration of the required parameters is managed directly by the R&S®HMC8015 after "Ethernet" has been selected as the interface, and the PARAMETER softkey has been pressed. A complete parameter configuration may be performed, including the allocation of a fixed IP address. Alternatively, a dynamic assignment of IP addresses is possible through activation of the DHCP function. Contact your IT manager for more information regarding the correct settings.

Once the device has an IP address, it can be reached with a web browser using this IP, since the Ethernet interface has an embedded web server. When the IP address is entered in the browser address bar (<http://xxx.xxx.xxx.xxx>), a window will appear with details on the device type and serial number.

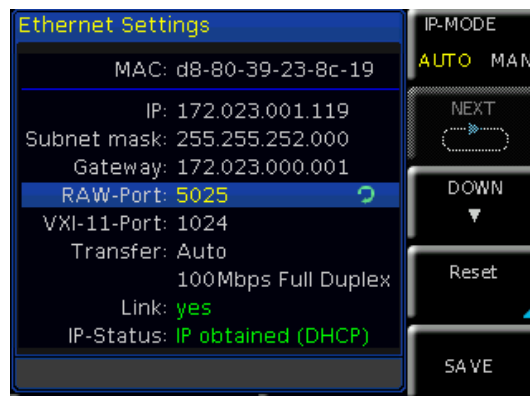

Fig. 10.11: Ethernet settings.

If DHCP is used and the R&S®HMC8015 cannot obtain an IP address (e.g. if no Ethernet cable is plugged in or the network does not support DHCP), it takes up to three minutes for a "time out" message to be returned, thereby clearing the interface for another configuration.

10.3.3 LXI

LAN eXtensions for Instrumentation (LAN LXI) is a device platform for measuring instruments and test equipment that is based on standard Ethernet technology. LXI as a LAN-based successor to GPIB is intended to combine the advantages of Ethernet with the simplicity and ease of use of GPIB.

The R&S®HMC8015 is LXI certified and complies with Version 1.4 (LXI Core 2011). Advanced features are not supported. The LXI certification central components are the Interchangeable Virtual Instrument (IVI) device drivers. These IVI.net drivers are based on Microsoft's .NET Framework 4. LabView and LabWindows/CVI drivers that were created based on LabWindows/CVI 2012 are also available.

10.3.4 Web Server

The Ethernet interface comes with a web server that can be used with any web browser (e.g. Internet Explorer). The web server supports the following features:

- Displaying the device data (Device information)



Fig. 10.12: Display of the device information

Remote Operation

■ Displaying the Ethernet settings (Settings)



Fig. 10.13: Ethernet settings

■ Password assignment (Security)

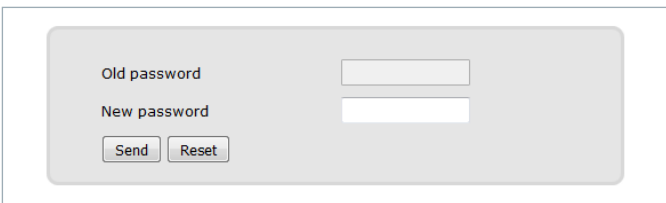

Fig. 10.14: Password setting

The Ethernet password can only be reset via HMC Ethernet menu (Ethernet --> Parameter --> Reset). The web browser function „Reset“ only resets the web browser parameter entry.

■ SCPI Terminal



Fig. 10.15: SCPI terminal

10.4 IEEE 488.2 / GPIB

The optional IEEE 488 (GPIB) interface can only be installed at the factory, since the unit must be opened and the warranty seal would have to be broken.

In addition to the GPIB features already made available by USB TMC, the R&S®HMC8015 is also available with an option that includes a GPIB interface (R&S®HMC8015-G). This solution may be attractive for those customers who already have an existing GPIB environment. In this way,

a new R&S®HMC8015 model can replace any existing outdated equipment with minimal conversion effort. The configuration of the required parameters is managed by the R&S®HMC8015 once “IEEE488” has been selected as the interface, and the PARAMETER softkey has been pressed.

11 Technical Data

Basic Specifications	
Measurement method	simultaneous voltage and current sampling
Analog bandwidth	DC to 100 kHz
Frequency accuracy	0.1% of reading
A/D converter resolution	16 bit (voltage), 16 bit (current)
Basic accuracy	0.05% of reading
Display resolution	5 digits
Sampling frequency	500 kHz
Filters	
Analog signal filter	1 kHz
Digital filter	automatic adaptiv filter
Frequency filter	500 Hz (independent from signal filters)
Additional rear panel inputs / outputs (BNC)	
Analog input	$\pm 10 V_p$
Analog input accuracy	0.5% of reading
Analog output	$\pm 5 V_p$
Digital input	
Low level	0V to 2V
High level	3V to 24V
Digital output	5V TTL (up to 100 mA source/sink)
Voltage input impedance	2 M Ω
PLL synchronisation sources	U, I, external

General Specifications	
Display	
Type	8.9 cm (3.5") TFT (Farbe)
Resolution	320 x 240 Pixel (QVGA)
Power supply	100 V _{ac} to 115 V _{ac} / 230 V _{ac} @ 50-60 Hz
Power consumption	35 W max, 15 W typ.
Operating temperature	5°C to 40°C
Storage temperature	-25°C to 60°C
Standards	CAN/CSA-C22.2 NO. 61010-1, UL 61010-1, DIN EN 61010-1, DIN EN 61326-1, DIN EN 55011
Common mode voltage	CAT II, 600 V _{rms}
Dimensions	222 x 88 x 280 mm
Weight	ca 3.250 kg
Warm-up time	60 minutes

Specifications apply to sine wave as input, PF = 1, voltage to earth = 0V, analog signal filter deactivated, digital filter activated and are valid above 1% of range.

Power Analyzer R&S®HMC8015			
Range configuration			
	CF3	CF6	Peak
voltage	5V 15V 30V 60V 150V 300V 600V	2.5V 7.5V 15V 30V 75V 150V 300V	$\pm 15V$ $\pm 45V$ $\pm 90V$ $\pm 180V$ $\pm 450V$ $\pm 900V$ $\pm 1800V$
current (500m Ω)	5 mA 10 mA 20 mA 50 mA 100 mA 200 mA	2.5 mA 5 mA 10 mA 25 mA 50 mA 100 mA	$\pm 15 mA$ $\pm 30 mA$ $\pm 60 mA$ $\pm 150 mA$ $\pm 300 mA$ $\pm 600 mA$
current (10m Ω)	0.5 A 1 A 2 A 5 A 10 A 20 A	0.25 A 0.5 A 1 A 2.5 A 5 A 10 A	$\pm 1.5 A$ $\pm 3 A$ $\pm 6 A$ $\pm 15 A$ $\pm 30 A$ $\pm 60 A$
sensor	0.033 V 0.33 V 1.33 V	0.0165 V 0.165 V 0.665 V	$\pm 0.1 V$ $\pm 1 V$ $\pm 4 V$
Measurement accuracy (\pm reading in % \pm peak range in %)			
Frequency	Voltage	Current / Sensor	Active Power
DC	0.05 + 0.05	0.05 + 0.05	0.05 + 0.05
f < 45 Hz	0.05 + 0.05	0.05 + 0.05	0.075 + 0.075
45 Hz < f < 66 Hz	0.05 + 0.05	0.05 + 0.05	0.05 + 0.05
66 Hz < f < 1 kHz	0.05 + 0.1	0.05 + 0.1	0.075 + 0.075
1 kHz < f < 10 kHz	(0.1 + 0.02 *F) + 0.1	(0.1 + 0.03 *F) + 0.1	(0.1 + 0.07 *F) + 0.1
10 kHz < f < 100 kHz	(0.1 + 0.04 *F) + 0.1	(0.1 + 0.04 *F) + 0.2	(0.1 + 0.07 *F) + 0.1
voltage, current: F = frequency in kHz sensor input: F = frequency in kHz *2			
Additional errors			
Power factor < 1	$\pm(0.2 + 0.2 *F)\%$, only for active power		
Common mode error	$\pm 0.01\%$ of peak range		

All specifications valid for a temperature range between 20°C and 30°C at 80% relative humidity after 60 minutes warm-up

12 Appendix

12.1 List of Figures

Fig. 1.1:	Operating positions.	4
Fig. 1.2:	Rear panel with supply voltage selector and connections.	6
Fig. 1.3:	Connections on the front panel.	6
Fig. 1.4:	Product labeling in accordance with EN 50419.	7
Fig. 2.1:	R&S®HMC8015 front panel.	8
Fig. 2.2:	R&S®HMC8015 rear panel.	8
Fig. 3.1:	Upgrade menu.	10
Fig. 3.2:	Manually entering the license key.	10
Fig. 4.1:	Connecting HZC815 DE version to R&S®HMC8015.	10
Fig. 4.2:	HZC815 DE, UK, US and CHN version plug adapters.	10
Fig. 4.3:	HZC815 DE version plug adapter with mounting screws.	11
Fig. 4.4:	Internal wiring of A, V and COM jacks.	11
Fig. 4.5:	Voltage-based measurement.	11
Fig. 4.6:	Voltage-based measurement, wiring example.	11
Fig. 4.7:	Current-based measurement.	12
Fig. 4.8:	Current-based measurement, wiring example.	12
Fig. 4.9:	HZC51 Clamp-on current probe.	12
Fig. 4.10:	Sensor menu.	12
Fig. 4.11:	Example of a sensor.	12
Fig. 4.12:	Sensor mode.	13
Fig. 5.1:	Screen display description.	13
Fig. 5.2:	Help function.	14
Fig. 5.3:	Selecting the measurement function.	14
Fig. 5.4:	Readout display with six active cells.	14
Fig. 5.5:	Readout display with 10 active cells.	14
Fig. 5.6:	Example of measuring range display.	15
Fig. 5.7:	Selecting the measurement function.	15
Fig. 5.8:	Manual measurement range selection via ACQ menu	15
Fig. 6.1:	R&S®HMC8015 readout display.	16
Fig. 6.2:	Option / upgrade voucher info box.	16
Fig. 6.3:	VIEW menu.	16
Fig. 6.4:	Logarithmic readout display in Harmonics mode.	17
Fig. 6.5:	Harmonics selection with rotary control knob.	17
Fig. 6.6:	Tabular display in Harmonics mode.	17
Fig. 6.7:	Quick Menu in Waveform mode.	17
Fig. 6.8:	Trendchart mode.	18
Fig. 6.9:	Inrush mode.	18
Fig. 6.10:	CSV export of an Inrush trace.	19
Fig. 6.11:	Example display of HMEExplorer software Power module.	19
Fig. 6.12:	Compliance Test menu	20
Fig. 6.13:	Settings menu EN 50564	20
Fig. 6.14:	HZC815 connection example EN 50564	20
Fig. 6.15:	Compliance Test measurement example EN 50564.	21
Fig. 6.16:	Settings menu IEC 61000-3-2.	21
Fig. 6.17:	HZC815 connection IEC 61000-3-2	22
Fig. 6.18:	Example of EN 50564 test report.	22

Fig. 6.19:	Compliance Test measurement IEC 61000-3-2	22
Fig. 6.20:	IEC 61000-3-2 Harmonic Currents	23
Fig. 6.21:	Test report example files on USB stick.	23
Fig. 6.22:	Sample configuration for crest factor 6.	23
Fig. 6.23:	Readout display with integrator output values.	23
Fig. 6.24:	MANUAL integrator menu.	24
Fig. 6.25:	Span integration mode selection menu.	24
Fig. 6.26:	Setting the integration duration.	24
Fig. 6.27:	Inversion.	25
Fig. 6.28:	Selecting the data acquisition mode.	25
Fig. 6.29:	Filters arranged as a chain.	25
Fig. 6.30:	LIMIT menu.	26
Fig. 6.31:	BNC connectors Digital / Analog IN/OUT.	26
Fig. 6.32:	ANALOG OUT menu.	26
Fig. 6.33:	Analog Out example	27
Fig. 6.34:	DIGITAL IN menu.	27
Fig. 7.1:	Graphical log file analysis in Excel.	28
Fig. 7.2:	Setting the integration duration.	28
Fig. 7.3:	User-defined customization of time stamp formatting in Excel.	29
Fig. 7.4:	Excel Import Wizard (Text Import Wizard).	29
Fig. 8.1:	Saving / Loading device settings	30
Fig. 8.2:	Screenshot settings menu	30
Fig. 8.3:	Screenshot module of the HMEExplorer Software	31
Fig. 9.1:	Setup menu.	31
Fig. 9.2:	Firmware update menu.	31
Fig. 9.3:	Instrument information.	32
Fig. 9.4:	Entering the instrument name.	32
Fig. 9.5:	CSV structure	32
Fig. 9.6:	"nan"-Interpretation Excel / Open Office	33
Fig. 10.1:	Rear panel.	33
Fig. 10.2:	USB VCP settings.	33
Fig. 10.3:	NI-VISA 5.4.1.	34
Fig. 10.4:	NI-VISA installation guide.	34
Fig. 10.5:	Installing NI-VISA application locally.	35
Fig. 10.6:	Setup menu.	35
Fig. 10.7:	Interface menu.	35
Fig. 10.8:	TMC display on the screen.	35
Fig. 10.9:	Device driver installation.	35
Fig. 10.10:	Display in the device manager.	35
Fig. 10.11:	Ethernet settings.	37
Fig. 10.12:	Display of the device information.	37
Fig. 10.13:	Ethernet settings.	38
Fig. 10.14:	Password setting.	38
Fig. 10.15:	SCPI terminal.	38

12.1 List of Tables

Table 3.1:	Overview of R&S®HMC8015 options/upgrade vouchers	9
Table 3.2:	Feature overview: options/upgrade vouchers	9
Table 6.1:	Overview of measurement functions.	16
Table 6.2:	Overview of SOURCE measurement functions in Trendchart mode.	18
Table 6.3:	Overview of sampling rates	18
Table 6.4:	Overview of LIMIT measurement functions.	26
Table 10.1:	Private IP address ranges	36
Table 10.2:	IP address classes.	36

12.3 Glossary

A

Acquisition Mode: 25
 Active Power: 9, 16, 18, 26
 Adapter: 10
 Analog IN: 26
 Analog OUT: 26
 Apparent Power: 9, 16, 18, 26

C

Cells: 14
 Compliance Test: 20
 Crest Factor: 23
 CSV: 32

D

Data Acquisition: 28
 Device Settings: 30
 Digital IN: 27
 Digital OUT: 27
 Display Modes: 16

E

EN 50564: 20
 Energy Counter: 23
 Ethernet: 36

F

Feature Overview: 9
 Frequency Filter: 25
 Frequency Source: 25

G

GPIO: 38

H

Harmonics Mode: 17
 HZC815: 10

I

IEC 61000-3-2: 21
 IEC 62301: 20
 Inrush Mode: 18
 Instrument Controls: 8
 Instrument Functions: 16
 Invert Function: 24

K

Key Fallback Time: 32

L

License Key: 9, 10
 Limits: 26
 Logging: 28
 LXI: 37

M

Measurement Categories: 6 Measuring
 interval: 28
 Measuring Range: 15

O

Options: 9

P

Peak Hold: 25
 Phase Shift: 9, 16, 18, 26
 Power Factor Lambda: 9, 16, 26 Probe:
 12

R

Reactive Power: 9, 16, 18, 26 Readout
 Display: 14
 Refresh Function: 25
 Repair: 5

S

Safety: 4
 Screen Display: 13
 Screenshots: 30
 Settings: 32
 Shunt: 12
 Softkeys: 14
 Supply Voltage: 6

T

Technical Data: 39
 Total Harmonic Distortion: 9, 16, 18, 26
 Trendchart Mode: 18

U

Update: 31
 USB Stick: 28
 USB TMC: 34
 USB VCP: 33

V

Vouchers: 9

W

Warranty: 5
 Waveform Mode: 17
 Web Server: 37

 北京海洋兴业科技股份有限公司

北京市西三旗东黄平路 19 号龙旗广场 4 号楼(E座)906 室

电 话: 010-62176775 62178811 62176785

企业 QQ: 800057747

www.hyxyyq.com

企业官网: www.hyxyyq.com

邮编: 100096

传真: 010-62176619

邮箱: info.oi@oitek.com.cn

海洋仪器, 致力于电子测试、维修领域

购线网: www.gooxian.net



扫描二维码关注我们
 查找微信企业号: 海洋仪器